

Design & engineering simulation solutions

Smarter Computer-Aided Engineering, virtual manufacturing & costing



About Hexagon design & engineering software

Accelerate smart change with CAE simulation

Hexagon's Design & Engineering simulation software business came about from the acquisition of MSC Software in 2017. We develop predictive simulation software technology that enables engineers to validate and optimize their manufactured product or process designs using virtual prototypes. Customers in almost every part of manufacturing use our software to complement, and in some cases even replace the physical prototype "build and test" process that has traditionally been used in product design. We partner with our customers to help improve quality, save time, and reduce costs associated with design and test of manufactured products. Our products accurately and reliably predict how products will behave in the real world to help engineers design more innovative products - quickly, cost effectively and right-first-time.

Our technology is used by leading manufacturers for linear and nonlinear finite element analysis (FEA), acoustics, fluid-structure interaction (FSI), multi-physics, optimization, fatigue and durability, multi-body dynamics, electro-mechanical drivelines, and control systems simulation. We pioneered many of the technologies that are now relied upon by industry to analyse and predict stress and strain, vibration & dynamics, acoustics, and thermal analysis in our flagship product, MSC Nastran.

The McNeal Schwendler Corporation (MSC) was formed in 1963 and was awarded the original contract from NASA to commercialize the finite element analysis (FEA) software known as NASTRAN (NASA Structural Analysis). MSC pioneered many of the technologies that are now relied upon by industry to analyse and predict stress and strain, vibration & dynamics, acoustics, and thermal analysis in our flagship product, MSC Nastran. Over our rich history, MSC has developed or acquired many other well-known CAE applications including Patran, Adams, Marc, Dytran, CAEfatigue, SimManager, Easy5, Sinda, Actran, Digimat, Cradle CFD, VTD, FormingSuite, MSC Apex, Romax, and Simufact. We are committed to the continued development of new CAE technology that integrates disciplines and technologies from standalone CAE tools into unified multi-discipline solvers and user environments. Our solutions enable engineers to improve the reliability and accuracy of their virtual prototypes by including multi-physics and multi-discipline interactions. We are also the CAE industry's leader in extending simulation to the engineering enterprise with Engineering Lifecycle Management solutions for materials and CAE data.

Our products and services are used by 900 of the top 1000 manufacturers in the world, spanning industries like:

- Aerospace and defense
- Agriculture
- Automotive and ground transportation
- Consumer products
- Electronics
- Heavy machinery
- Materials
- Medical devices
- Oil and gas
- Power generation
- Renewable energy

Our customers recognize the need to scale the benefits of virtual prototyping and testing from research of experts to mainstream engineering analysts and product development. We offer a Materials Data and Process Management platform as well as the only Simulation Data and Process Management solution in the world that has been successfully deployed in industries including automotive, aerospace, shipbuilding, electronics, and more. We are part of Hexagon AB (Nasdaq Stockholm HEXA:B), a 4 billion Euro software a global leader in sensor, software and autonomous solutions with over 20,000 employees.



Message from our General Manager

Dr. Mahesh Kailasam

For over half a century we have been delivering certainty to our customers. By simulating the reality of complex manufactured systems through our software, we deliver certainty so our users can delight their customers with great products, and certainty in business results by reducing time to bring the right products to market, reduce physical testing and warranty claims long after product design is over.

We do this by pushing the edge of physics simulation and the latest computing technology to simulate real world behaviours. These principles that we were founded upon continue as our guiding light under Hexagon. We help to make cars safer and more efficient, airplanes more aerodynamic and more comfortable for passengers, ships stronger and able to travel longer distances, machinery to run more efficiently and with less maintenance, and medical devices more effective to help us live longer.

Our customers are faced with difficult questions every day; can I reduce the time it takes to develop? Will it work? Will it be innovative? Will it be safe? Will it be fuel efficient? Will it provide a new standard of passenger comfort? Will it last longer? Will it allow me to beat my competitors? By knowing exactly how products will behave before they are built, manufacturers can deliver better products faster, with more reliability, and without worrying about recalls. Our software also allows you to comply with environmental and legislative standards and deliver sustainable manufacturing.

The first adopter of CAE simulation technology was the aerospace industry. The challenge of safe flight from the very first test onwards drove it to push the state-of-the-art in technology, long before any other industry. MSC became and has remained a trusted partner with the world's leading aerospace companies, delivering certainty every step of the way. In 2003, NASA put a value to society in excess of 10 billion dollars on the NASTRAN structural analysis simulation software delivered by us. Eventually, this kind of simulation technology became broadly adopted in nearly every industry from automotive to machinery, energy to infrastructure, consumer products to electronic devices. Virtually every major OEM and manufacturer in the world is a customer today. Call us, find out more, and see how we are enabling the future of autonomy and helping you make things smarter in the 21st century.



Mahesh Kailasam - General Manager, MSC Software and EVP Design and Engineering Software, Manufacturing Intelligence division, Hexagon

Table of contents

About Hexagon design & engineering software	2
Message from our General Manager	3
Table of contents	4
Our solution portfolio	6
MSC One	7
Unlock the world of engineering simulation with our portfolio token system	
MSC Apex Generative Design	9
Automated lightweight design optimisation Discipline: Design	
MSC Apex Modeler	11
Direct modeling & meshing solution Discipline: Structures & multiphysics	
MSC Apex Structures	13
Computational parts based structural analysis Discipline: Structures & multiphysics	
Adams	15
Multibody dynamics simulation solution Discipline: Mechanisms & multibody dynamics	
Romax	17
Integrated simulation suite for ePowertrain Discipline: Electro-mechanical	
Actran	21
Powerful acoustic simulation software Discipline: Acoustics	
MSC CoSim	23
Where multiphysics gets real	
Cradle CFD	24
Multiphysics focused computational fluid dynamics software	

Our solution portfolio

Industry-leading simulation portfolio

Hexagon's design & engineering business makes products that enable engineers to validate and optimize their designs using virtual prototypes and digital twins. Customers across all manufacturing industries use our software to complement, and in some cases even replace the physical prototyping for product and process design, development, testing and deployment to eventual retirement or recycling in the increasing circular economy...

Hexagon's design & engineering software product portfolio

Research and development Design and engineering Prototyping Manufacturing and production Inspection (V&V, metrology) Quality control Launch Lifetime Recycle		
VOLUME GRAPHICS Quality assurance VOLUME GRAPHICS		
C O - S I M U L A T I O N	Costing	
	Structures	MSC NASTRAN, MSC APEX, MARC, CAefatigue, PATRAN, DYTRAN, SIMUFACT, FORMINGSUITE, DIGIMAT
	Fluids	CRADLE CFD (scFLOW, scSTREAM, HeatDesigner) ADAMS
	Multibody Dynamics	ADAMS
	Electro-mechanical	ROMAX (CONCEPT, ENDURO, ENERGY, SPIN, SPECTRUM, EVOLVE)
	Acoustics	ACTRAN
	Materials	MATERIALCENTER, DIGIMAT
	Systems	EASY5, VTD
	Data management	SimMANAGER, MATERIALCENTER



MSCOne

Unlock the world of engineering simulation with our portfolio token system.

MSCOne is a product token system that lets you take advantage of the breadth and depth of our simulation portfolio within a flexible token-based licensing system*.

Typically offered on an annual subscription basis, MSCOne provides efficient implementation of your investment in product development with access to a suite of multidisciplinary engineering software tools.

Key aspects of MSCOne include:

- As a subscription product, MSCOne's capacity can be expanded or contracted based on current and future project needs.
- Access to more connected physics and disciplines allows better prediction of part and system's multiphysics behaviour.
- Ability to leverage MSC's ecosystem of products including; MSC Apex, MSC Nastran, Patran, Adams, Marc, SimManager, MaterialCenter and more.
- Substantially all current and future MSC products will be available in MSCOne.

With the subscription-based token system, you receive a pool of tokens. Your tokens are checked out from the pool and are used to access and run a full range of CAE solutions available under the MSCOne licensing system.

Each individual software item requires a certain number of tokens to run. After each use, your tokens are returned to the pool for other use. There are dozens of software items available under MSCOne.

Who is it for?

- Large-scale global enterprises.
- Small-medium sized companies with tight budgets and heavy engineering needs.
- Consulting firms that cannot invest in multiple outright per-seat purchases.

**Exceptions do apply with certain products. Please talk to our representatives for more information.*

How MSCOne Works

MSCOne^{SE} Starter Edition

Get started with the most cost effective and flexible token system for your simulation needs.

MSCOne^{SE} is a flexible token-based licensing system that provides access to many of our key structural and fluid simulation portfolio*.

Typically offered on an annual subscription basis, MSCOne^{SE} provides a low cost, low risk entry point for those looking to get started with a suite of multidisciplinary engineering software tools.

- Access to core structural and fluid simulation tools to allow for better prediction of part and system multiphysics behaviour.
- Tiered entry price point depending on number of users.
- Perfect for small to medium sized companies and consulting firms with tight budgets and heavy engineering needs.



MSCOne^{XT} Extended Edition

Extend the most powerful token system to take you further with trusted partner tools.

MSCOne^{XT} is an extension to MSCOne. MSCOne^{XT} provides access to an ever-evolving suite of software tools that have been developed by our technology partners to complement the solution portfolio within the MSCOne token system.

- MSCOne^{XT} uses your existing tokens and unlocks access to complementary third-party tools.
- Provides access to one simultaneous session of all third-party partner tools at no additional cost*.
- Extends the capability and usability of existing MSCOne tools with complementary partner products.



MSC Apex | Generative Design

Automated lightweight design optimisation

MSC Apex Generative Design is the fully automated generative design solution built on the intuitive CAE environment of MSC Apex. It exploits its easy-to-use and easy-to-learn features while employing an innovative generative design engine in the background. This combination of advantages dramatically decreases the effort required in the design optimisation workflow.

MSC Apex Generative Design is designed specifically to generate the detailed and highly complex structures that only additive processes can manufacture. The innovative, stress-based algorithm derives distinct geometries by minimising mass, creating geometries that are truly unimaginable by the human mind.

- Automated design: Almost automatically generate multiple smoothed design candidates that all satisfy the design criteria while minimising the weight.
- Simplicity: No expert knowledge required for conducting optimisations through a high user-focused software design.
- Import and validation: Import existing geometries or mesh, find optimised design candidates, and perform design validation – all inside a single CAE environment.
- Direct output: Export geometry that can be directly manufactured and used immediately without manual rework.
- One process: Import the resulting geometries in Simufact Additive or Digimat-AM to achieve cost-efficient first-time-right result for every part and validate them with MSC Nastran or MSC Apex Structures.

Productivity gains

A race car's wheel carrier with 9 load cases was optimised within 6 hours instead of usually more than 1.5 weeks of work. The optimisation's result is an already smoothed geometrically and mechanically correct design that is ready for manufacturing. By cutting the weight through the optimisation to almost 50%, production runtime and costs were significantly reduced. Through a production with additive manufacturing, scrap can be significantly reduced which increases the overall sustainability of the car.

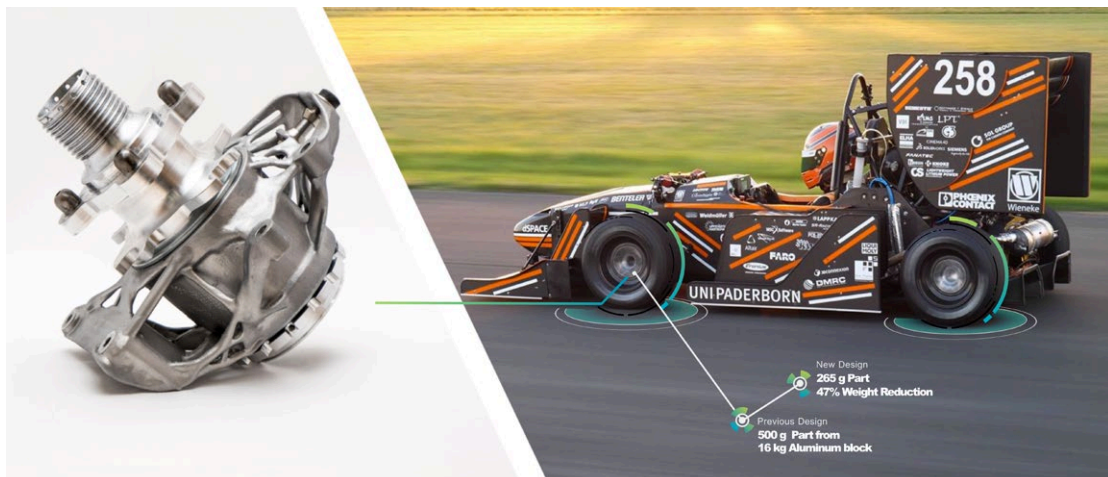



Capabilities

- Import CAD files
- Direct and fast creation of (multiple) optimisation model(s)
- Automated optimisation process of linear static load cases
- Integrated smoothing for clean surfaces & perfectly shaped transitions between struts and shell structure
- Significant weight reduction through a stress-based algorithm
- Generative design studies to create a variety of results in a short time
- Directly transfer the result to native CAD format based on NURBS
- Solving on CPU, Nvidia GPUs and remotely on Windows
- - Local coordinate systems, pressure, gravity
- - Simulation of isotropic and non-isotropic material (3D transversely isotropic and 3D orthotropic material)

Benefits

- New, innovative design mindset – no manual construction necessary
- Easy-to-use software does not require an extensive training period
- Cost savings through a much more efficient process of product design.
- Multiple design candidates generated based on optimisation settings
- Direct and feasible part design output
- Generated results are tailored for a direct AM production and utilise the technology's potentials
- Interoperability for mechanical integrity validation and manufacturability
- Generation of highly complex, organic shaped lightweight designs for reduced production and operation costs.
- Leaner production and more efficient parts increase the company's sustainability.

MSC Apex | Modeler

Direct modeling and CAD-and-Mesh solution

MSC Apex Modeler is a CAE specific direct modeling and CAD-and-Mesh solution that streamlines CAD clean-up, mesh creation and attributes setting workflow. The solution features sophisticated and interactive tools that are easy to use and easy to learn.

- **Smart tools:** MSC Apex features a complete set of direct modeling tools to make geometry clean-up and idealization steps in an extremely fast and efficient manner. Simply select the entities of interest and push/pull or drag to implement any modifications. Such tools allow users to clean up geometry without any prerequisite experience and can reduce the number of user operations by a factor of 10.
- **Product workflows:** MSC Apex has also been architected with smart FEA/CAE workflows in mind. A representative example is the smart mid-surfacing capabilities that enable the fast converging of 3D FEA models to 2D models. Users can easily achieve 10x productivity gains in a typical CAD to analysis-ready FEA workflow by employing the workflows provided by MSC Apex.
- **Underlying technologies:** MSC Apex incorporates a generative framework to enable full associativity between the geometry and analysis data. Once the 'upstream' object has modifications, the change will be synchronized to 'downstream' objects automatically, including mesh, attributes, and even simulation results. This Direct-modeling is unique in the CAE industry and provides a tremendous user experience benefits.
- **Easy to use, easy to learn:** MSC Apex is designed to have multi-purpose tools to make the application easy to use. It also features numerous learning aids such as tutorials, video-based documentation, workflow, and at-mouse instructions which promotes single day productivity

Productivity gains

Geometry creation and meshing of this aerospace bulkhead required 50 hours with conventional CAE tools. In MSC Apex Modeler, the process only took 5.5 hours and required little effort to extract mid-surfaces, connect separate surfaces, mesh, and assign thicknesses and offsets.

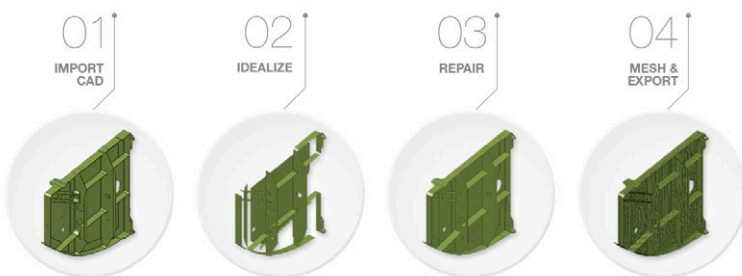

	Today's Workflow	MSC Apex Workflow
Expertise Required	High	Low
Analysis geometry creation	35h	3h
Mesh creation	3h	2h
Property Assignments	12h	0.5h
Complete entire scenario	50h	5.5h

Capabilities

Sketching

- Sketch lines, squares, circles, ellipsoids, fillets, chamfers, and high-order geometries
- Project, split, and edit existing sketches

Geometry edits with direct modeling

- Identify features and automatic defeature
- Interactively edit solids and surfaces with Push/Pull or Vertex/Edge drag
- Split and fill surfaces
- Add/Remove and Suppress/Un-suppress vertices or edges
- Support automatic part replacement in an assembly

Midsurface creation and repair tools

- Extract mid-surfaces by auto offset, constant thickness, distance offset, or tapered methods
- Incrementally build mid-surfaces of uniform or non-uniform thickness for planar or curved solids

Geometry extraction from orphan mesh

- Generate, modify and re-use/re-mesh faceted and 'real' NURBS geometry from legacy FEA models
- Modify and update facet geometry zones with user control
- Recognize 2D and 3D features for subsequent geometry edits
- Export retrieved geometry to widely used file format

Meshing and mesh editing

- Mesh curves, surfaces, and solids, available element types: Beam, Quad, Tria, Tet, Hex
- Regenerate meshes automatically as geometry is modified
- Refine meshes with Feature Base Meshing, mesh Seeding and mesh control curve

- Construct Hard Points to facilitate part connection
- Mesh surfaces via paver, 4 side map, or 4+ side map mesh methods
- Visually inspect element quality

Model attribution

- Material Creation and Assignment
- Behavior Creation and Assignment
- Automatic creation of thickness and offset properties for uniform and non-uniform cross sections
- Definition of interaction tools, including Ties and Discrete Connectors
- Definition of gravity load, point load, enforced motion, constraints, and press load

Interoperability with gold-standard solvers

- Continuously extended import, export and MSC Nastran-generated data support
- "Abstraction" concept for closer Apex/MS Nastran integration
- Support access to Adams/Car model/results data for post-processing
- Enable Geometry association and loads mapping between Adams/Car result data and structural FEA model in a single environment

Productive post-processing

- Embed image/movie capture function in GUI
- Enable multi-view result exploration environment

Automation via Python-based API

- Allow user-defined tools to automate repetitive work and develop in-house workflow
- Provide full IDE support
- Support Macro record and reply without coding

MSC Apex | Structures

Computational parts based structural analysis

MSC Apex Structures is an integrated module of a Finite Element Analysis solver, which provides users access to linear (and very soon, nonlinear) structural analysis. Currently, Apex supports four types of linear analysis, including linear statics, linear buckling, normal modes, and frequency response analysis.

MSC Apex Structures is a package with an intuitive user interface for scenario definition, analysis readiness check, and integrated solver. The integration of the user interface with solvers gives users a unique ability to validate and solve FEA models interactively and incrementally. This Incremental Validation and Solution philosophy is a creative and intelligent revolution to the very time-consuming traditional FEA workflow where pre/post processor and solver are separate.

With continuously extended supports of “MSC Apex - MSC Nastran - MSC Apex” workflow, users can pick the best scenario according to different design stages and tasks:

Scenario 1 – External MSC Nastran solution

Many existing MSC Nastran users will determine to use MSC Nastran as an external solver, due to their in-house process and/or client requirements.

Scenario 2 – Integrated MSC Apex Structures solution to support external MSC Nastran solution

The integrated solver can be used for incremental building and validation of FEA models as they are developed. Once verified as working representations, the run-ready FEA models can be solved externally with MSC Nastran, for subsequent result exploration through MSC Apex.

Scenario 3 – Embedded MSC Apex Structures solution

In the case where an MSC Nastran solution is not mandatory, the user can take advantage of the full capability of the embedded MSC Apex solver.

Productivity gains

Computational Parts technology was used to perform an incremental analysis of this landing gear door assembly. After modifying one part of the assembly, an incremental or subsequent analysis completed 2.5x faster than its first solve.

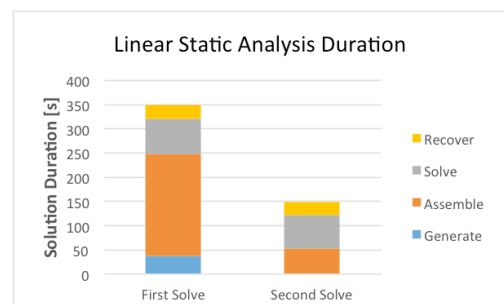
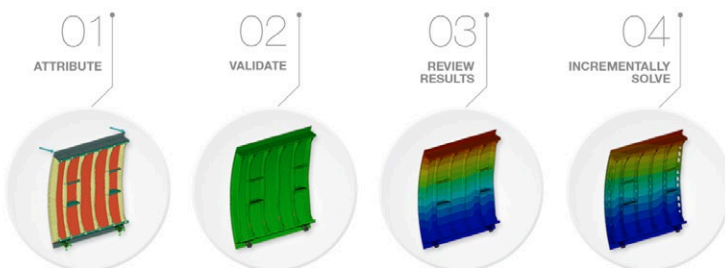

Capabilities

Linear structural analysis

Offer 4 types of linear simulations

- Linear Statics Analysis
- Linear Buckling Analysis
- Normal Modes Analysis
- Frequency Response Analysis

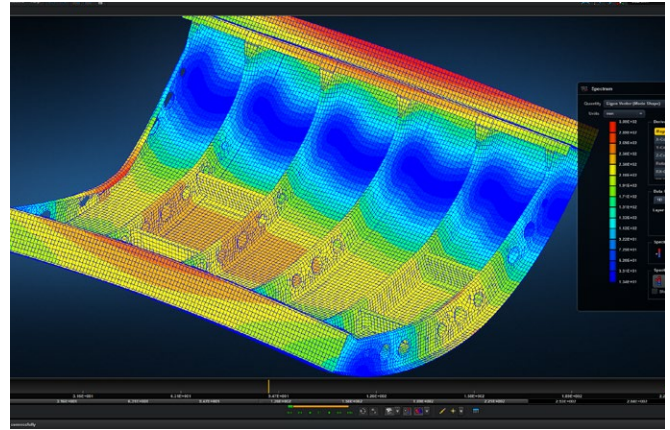

Incremental validation and solving

- Automatic Analysis Readiness check that covers geometry integrity, mesh quality, materials properties, loads and constraints, interactions, and simulation settings
- Manage multiple scenarios (model representations, output requests, analysis type)
- Context-specific calculation (Part, Sub-assembly, Assembly)

Generative framework

- Quickly update simulation results when “upstream” objects are modified

Adams

Simulate mechanism dynamics

Adams helps engineers study the dynamics of moving parts and how loads and forces are distributed throughout mechanical systems. Engineers often struggle to understand actual system performance until very late in the design process. Mechanical, electrical, and other subsystems are validated in silos, against their specific requirements within the systems engineering process. Still, full system testing and validation come late, leading to rework and design changes that are riskier and more expensive than those made early on.

Using Adams, Engineers can evaluate and manage complex interactions between disciplines, including motion, structures, actuation, and controls, to optimize product designs for performance, safety, and comfort. Adams improves engineering efficiency and reduces product development costs by enabling early system-level design validation. Along with extensive analysis capabilities, Adams is optimized for large-scale problems by leveraging high-performance computing environments.



As an MBD solution, Adams models run in a fraction of the time required by FEA solutions. Loads and forces computed by Adams simulations improve the accuracy of FEA by providing a better assessment of how they vary throughout a full range of motion and operating environments. With Adams, you don't have to wait until the computations are complete to begin seeing your simulation results. You can view animations and plots – and continue to refine your design – even as your simulation is running, saving valuable time. For design optimization, you can define your variables, constraints, and design objectives, then have Adams iterate automatically to the design, providing optimal system performance.

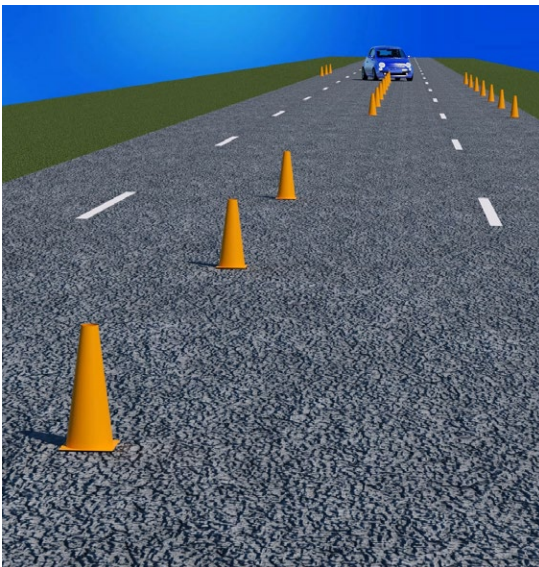

Adams Car

- Explore the performance of your vehicle design and refine it before building and testing a physical prototype
- Analyse vehicle design changes faster and at a lower cost than physical testing would require.
- Work in a secure virtual environment without the fear of losing data from instrument failure or losing testing time because of poor weather conditions.
- Open, extensible architecture with a template-based modeling paradigm allows vehicle models to be built and tested quickly.
- Pre-defined set of driver-focused vehicle events to virtually assess performance.

Adams capabilities

- Import of CAD geometry formats including STEP, IGES, DXF, DWG or Parasolid
- Extensive library of joints and constraints to define part connectivity
- Definition of internal and external forces on the assembly to define your product's operating environment
- Model refinement with part flexibility, automatic control systems, joint friction and slip, hydraulic and pneumatic actuators, and parametric design relationships
- Ability to generate flexible parts without the need to import MNF file from FEA software
- Ability to iterate to optimal design through definition of objectives, constraints, and variables
- Automatic generation of linear models and complex loads for export to structural analyses
- Comprehensive and easy to use contact capabilities supporting 2D and 3D contact between any combination of modal flexible bodies and rigid body geometry
- Comprehensive linear and nonlinear results for complex, large-motion designs
- Incorporate geometric and material nonlinearity through Adams-Marc co-simulation
- Create geometric nonlinear beam parts using FE part

Adams machinery

- High-fidelity simulation of common mechanical parts, such as gears, bearings, belts, chains, Electric Motor and Cam
- Enhanced productivity with incredibly quick model-solve-evaluate process times
- An automated, wizard-driven model creation process for ease-of-use
- Straightforward evaluation of results in Adams/Postprocessor

Adams Real Time

- Connect real equipment and virtual models in a HIL test environment to test system interactions.
- Connect a real driver and virtual models in a DIL test environment to assess vehicle and Driver performance
- Connect Adams and VTD to capture high frequency responses in autonomous simulations

Adams Modeler

Built on the Apex platform and powered by the Adams solver, Adams Modeler is a new Adams user experience that simplifies core mechanism modeling tasks and makes the benefits of utilizing Adams more accessible.

Optimized CAD management workflows

- Powerful drag and drop capabilities to adjust the CAD hierarchy
- Direct Editing of geometry to make design changes

Optimized model creation workflows

- Association between model objects and geometric features allows easy creation and modification of objects
- Accelerators intelligently predict location and position of modeling objects to accomplish object definition in fewer clicks.

Integrated FE capabilities

- Flex bodies can be natively created from rigid parts automatically
- Changes to the underlying geometry automatically updates the flex body.

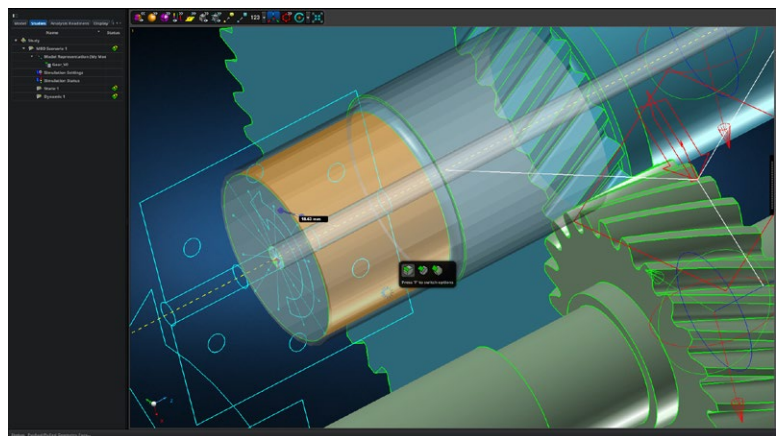

Romax

Integrated simulation suite for ePowertrain

Romax is a portfolio of industry-leading and award-winning electro-mechanical simulation applications. From rapid modelling and concept exploration to detailed simulation and virtual product sign-off, Romax applications align with your drivetrain and transmission development cycle. Intelligently integrated into the wider CAE world, Romax empowers your teams and enables Right First Time designs.

Romax products:

- Are **specific to drivetrain** applications: from automotive to aerospace, wind to rail, our tools provide optimized simulation methods and workflows for rotating machinery design and analysis.
- Offer a **whole system** approach: to understand complex component interactions and design the system holistically, using an engineering-based parametric definition of each component.
- Are based on **trusted and validated proprietary technology**: parametric full system definition, intelligent combination of analytical, empirical, and finite element methods and world-leading gear and bearing contact models.
- Are **fast and easy to use**: build and analyse models in minutes. Use rapid, actionable results to understand the effect of design changes, ask 'what if' questions and get instant engineering insight.
- Promote **CAE-led design**: combine easily editable models with upfront, repeatable, multi-fidelity analyses and multi-attribute optimisation to make smarter engineering decisions and reduce the risk of innovation.
- Enable **virtual prototyping**: rely on trustworthy simulation to reduce physical prototyping, shorten development times, and reduce costs.
- **Improve processes**: flexible product suite which promotes collaboration and efficient working, including optimisation and process automation, to boost productivity.
- Are part of an **integrated ecosystem** within Hexagon and beyond: for powertrain design which breaks down barriers within and across organisations through CAE integration and links with CAD and FEA.
- Based on **decades of deep powertrain expertise** and vast project delivery experience and backed up by expert global support.

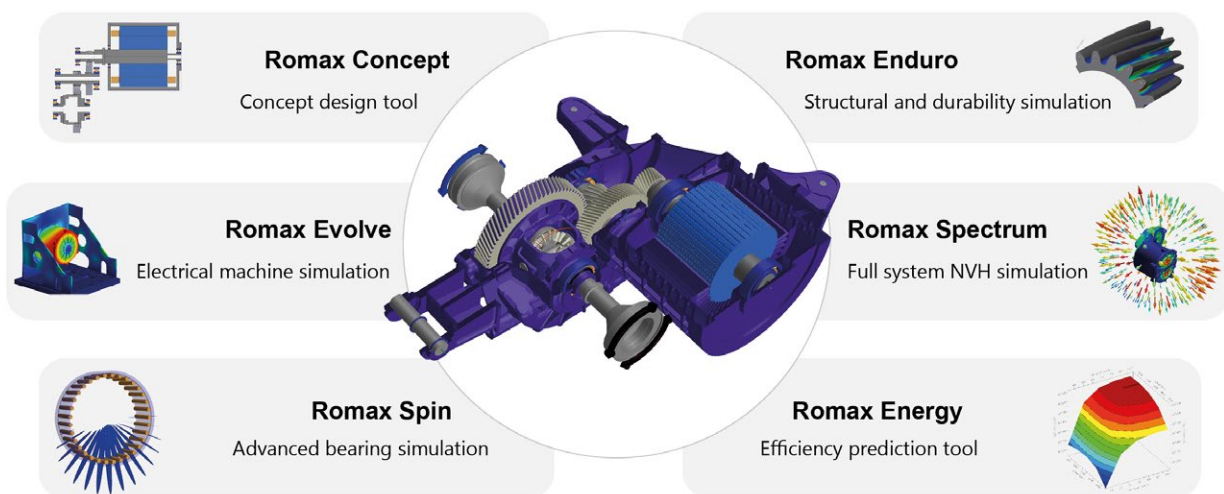

Romax Concept: explore drivetrain layouts quickly with a rapid model builder, sizing, optimisation, and multi-physics analysis to establish design direction and de-risk transmission design

Capabilities

- Component design considering whole system interactions and whole vehicle performance
- Early stage analysis - analyse the performance of a design concept in seconds and manage trade-offs between vehicle performance, durability, component life, efficiency, range, NVH, packaging, weight, cost, etc.
- Fast intuitive modelling – create and compare full system drivetrain simulation models in minutes via an easy-to-use drag-and-drop interface
- Dedicated tool for gearbox and electric motor design

Benefits

- Multi-physics drivetrain analysis before any CAD and FE
- Low barrier-to-entry, easy to train new engineers to increase your team’s drivetrain design output
- Explore possible designs to find the optimum concept early and make informed engineering decisions, leading to reduced costs and de-risked innovation
- Streamline design processes through integration with multi-body dynamics, CAD, motor design tools, CAE

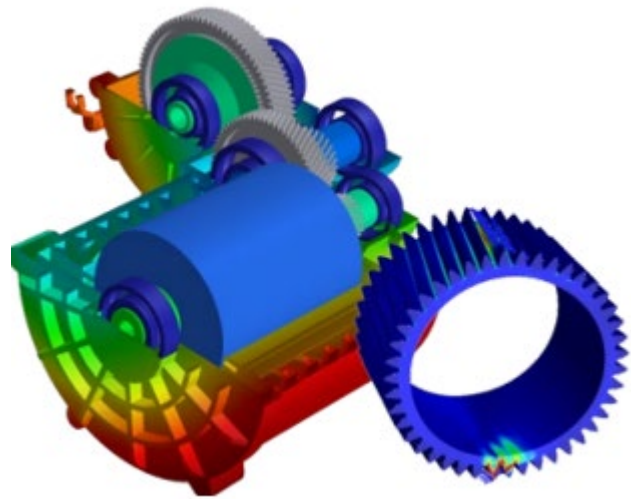

Romax Enduro: trusted structural simulation and optimisation for the design of durable and robust electro-mechanical drive systems

Capabilities

- Validated, full system drivetrain structural analysis combines state-of-the-art component contact models with standards and stress-based life calculations
- Component and system level static results, including deflections, misalignments, loads and stresses
- Gear design and optimisation accounting for load dependent system misalignments and considering manufacturing

Benefits

- Fast parametric and automatable modelling enabling CAE-led design exploration
- Multi-fidelity simulation for the right balance of speed and accuracy from concept to detailed design
- Understand system performance early to minimise prototyping and make confident engineering decisions
- Consider manufacturing at the design stage to ensure manufacturability and robustness
- Interfaces to CAD, FEA and other CAE tools for efficient workflows and robust exchange of design data
- Perform parametric studies for optimisation and variability studies, and batch running for automation and multi-domain system analysis

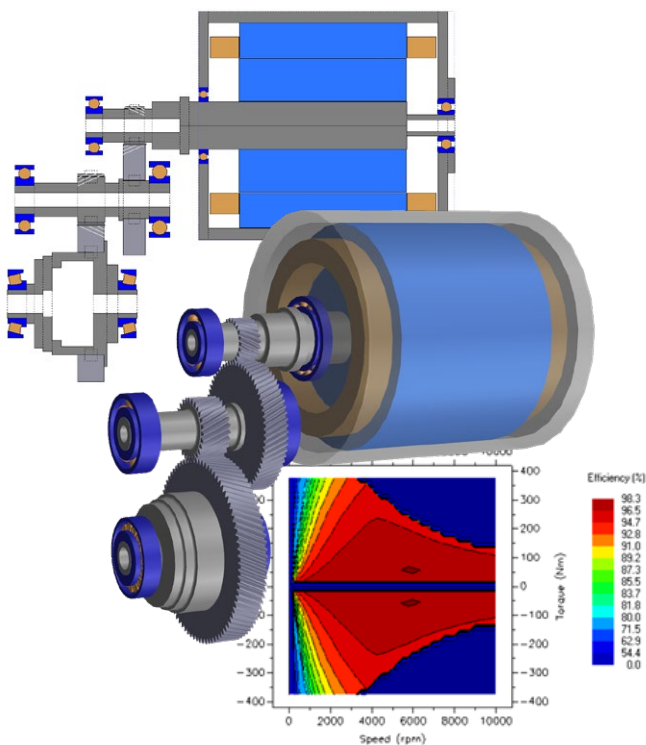

Romax Spectrum: full system NVH simulation from gear and electric machine design through to vehicle sound quality

Capabilities

- Full, integrated powertrain modelling, simulation, analysis and optimisation for vibration and radiated noise
- Validated analysis to predict dynamic gear excitations, unique planetary gear simulation, and links to electromagnetic software to calculate motor forces
- Fast frequency domain simulation of system vibration response
- Embedded acoustic solver brings complex radiated noise simulation to the non-expert, with automated calculations to verify design targets

Benefits

- Provides the accuracy required for sensitive NVH simulations, to gain engineering insight and make confident design decisions
- Enables CAE-led design through early consideration of NVH with fast, validated, intuitive simulation and analysis that help you deliver better designs faster and with less NVH testing and prototyping
- Links to other gold-standard products for vehicle NVH simulation, multibody simulation, and electric machine excitations

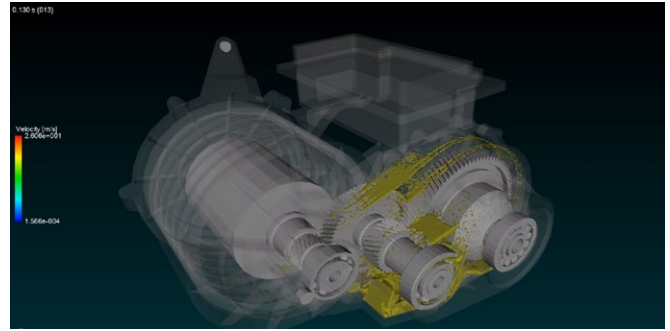

Romax Energy model simulated in Particleworks

Romax Energy: predict drivetrain and transmission efficiency to get insight into component and system performance

Capabilities

- Calculate transmission power loss, energy/fuel consumption and emissions using widely-used industry methods and our proprietary drag models
- Accurate prediction of the lubricant's effect on system efficiency, based on FVA345 methodology, so you can select or design the optimal oil
- Parametric study to investigate the impact of parameters (e.g. torque, speed, temperature, lubricant level) on system efficiency

Benefits

- Meet efficiency targets by making reliable design improvements, using comprehensive efficiency models to predict power losses
- Design and optimise components for efficiency by investigating the impact of varying geometric and operational parameters on system performance
- Democratized Particleworks interface brings CFD into the design stage for increased quality at reduced time to market

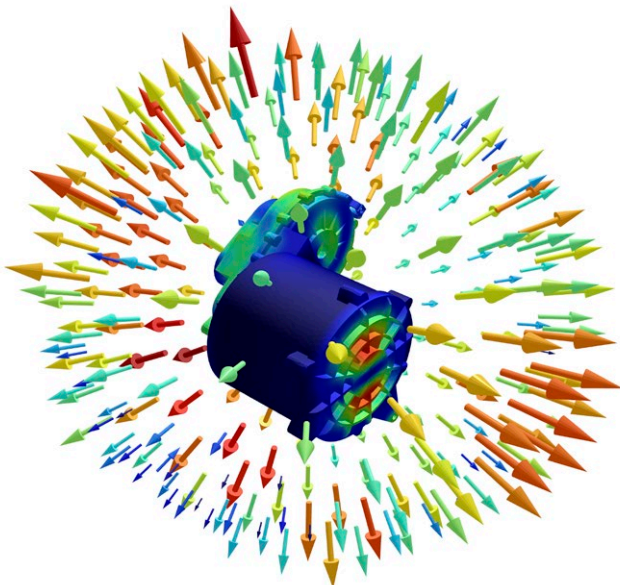

Romax Spin: advanced simulation of rolling element bearings for bearing designers and application engineers

- Access more than 60,000 bearings from SKF, Schaeffler, Timken, JTEKT, and Nachi or model fully customisable bearings and specify assembly and operating properties
- Accurate prediction of element and raceway stresses, rib contact, edge stress, roller contact analysis, and contact truncation, considering full system deflection, load analysis and bearing misalignments
- Time domain simulation to analyse dynamic behaviour and avoid novel failure modes such as skidding

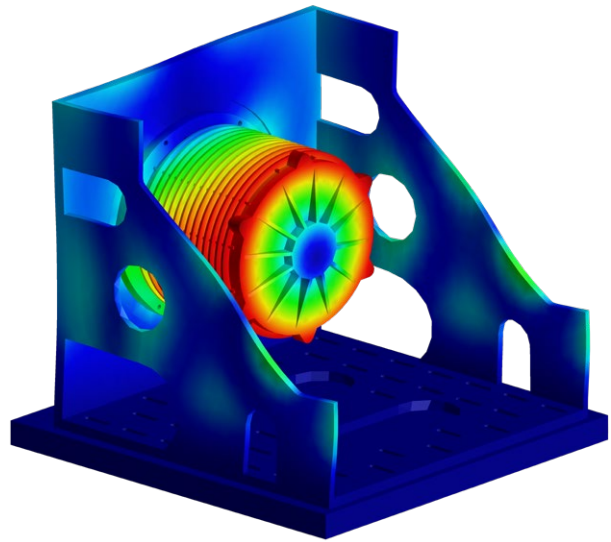

Benefits

- Collaborative working – facilitating easy data exchange between suppliers and customers, whilst protecting valuable IP
- Advanced analysis - fast enough to be used throughout development yet accurate enough to capture fine details of contact stress and its effect on bearing performance and life
- Engineering insight - to design or select optimal bearings for a specific application, to understand failures and identify appropriate counter-measures

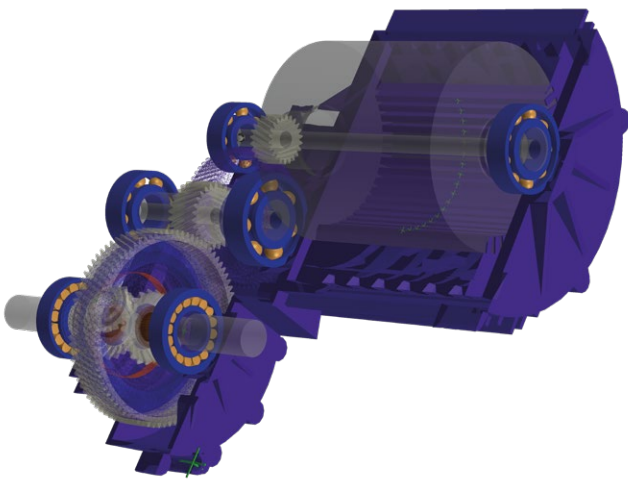

Romax Evolve: electro-mechanical analysis tool for electrical machine designers

- An application-specific set of tools for the structural and NVH analysis of electrical machines
- Simple, parametric structural modelling, including comprehensive bearing catalogs, FE components, and links with CAD and electromagnetic software packages for eMachine geometry and excitation import.
- Fast static analysis of eMachine housing, shaft deflections, bearing durability and power loss, rotor shaft dynamic behaviour, and consideration of UMP
- eMachine NVH simulation – including an embedded acoustic solver to bring radiated noise simulation to non-experts

Benefits

- Easy to use tools based on trusted expertise and proven electro-mechanical capability
- Democratized eMachine CAE-led design process – with multi-fidelity simulation usable throughout development to prevent problems before they arise
- Interfaces and workflows to major electromagnetic packages to enhance your existing tool chain

Actran

The gold standard in acoustic simulation

There is virtually no field of engineering that remains untouched by acoustic simulation technology. The reason is simple: no industry can afford to deliver a product that is too loud or does not sound right.

Actran has helped transportation, aerospace and defense, machinery, and consumer goods industries to meet increasingly stringent noise regulations or to guarantee that new designs are consistent with the trademark sound of the company.

Thanks to a rich library of modeling capabilities and high-performance solvers, engineers can deal with acoustic, vibration or flow-induced noise challenges in limited timeframes. A user-friendly and highly customizable graphical user interface ensures a robust and cost-efficient integration of numerical acoustic simulation into any industrial process.

Some applications

- Powertrain, gearbox and electric engine noise prediction
- Characterization of engine air intake and exhaust systems acoustic signature
- Side mirror and climate control aero-vibro-acoustic noise analysis
- Tyre and pass-by noise assessment including acoustic treatment optimization
- Interior vehicle acoustic comfort including fully trimmed vehicle NVH performances assessment and sound package optimization
- Transmission Loss prediction of multi-layered structures considering frequency-dependent acoustic treatment effects
- Transfer path analysis and design changes impact comparison
- Fan noise assessment considering installation effects (structure vibrations, acoustic absorption, ...)
- Audio equipment integration performance assessment
- Acoustic treatment and nacelle design optimization for aircraft intake and exhaust noise
- Airframe aero-acoustic noise prediction and propagation
- Underwater noise propagation
- Prediction of vibro-acoustic fatigue due to intense random acoustic load and vibrations

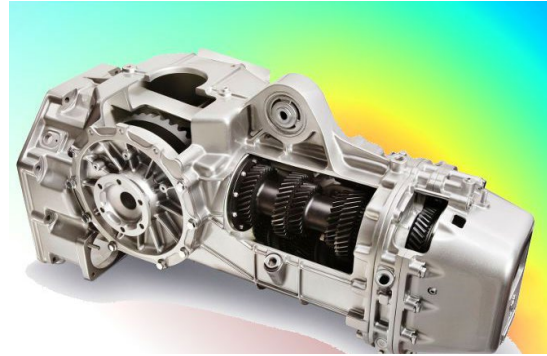
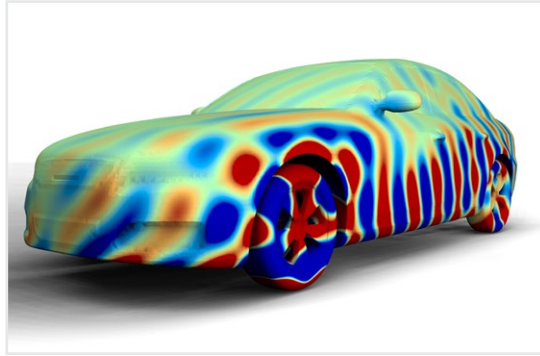

Benefits

- Predict, understand, and improve product design acoustic performance while shortening optimization processes thanks to latest HPC technologies
- Seamless integration of acoustic performance assessment in existing industrial processes thanks to native file format drivers and flexible API
- Increased productivity and robustness of acoustic analysis thanks to a customizable interface

Capabilities

- GUI support for advanced results visualization including dedicated acoustic post-processing capabilities (polar charts, 3D directivity maps, contribution charts, acoustic indicators)
- Access to embedded standard acoustic indicators (ISO 3744, ISO 3745, SAE J1074 and IEC 61672-1)
- Customizable interface based on user-defined process and requirements
- Adaptive solver-based meshing technology for efficient computation and users' minimal meshing efforts
- Integrated co-simulation with multi-body time domain code Adams or CFD code scFLOW
- Co-simulation with structural analysis FEA software like MSC Nastran
- Analyse acoustic propagation and radiation in static medium or complex flow

- Simulate free field radiation with infinite elements or Adaptive Perfectly Matched Layer (APML)
- Model acoustic visco-thermal loss in small fluid domains
- Coupled vibro-acoustic analysis with direct frequency approach or modal frequency approach
- Rich structure element library: solids, shells, beams, springs, rigid bodies, multi-layered composite structures etc.
- Poro-elastic element library based on the BIOT theory for modeling bulk reacting materials
- Piezo-electric element libraries for modeling active structures
- Random excitations: diffuse sound field, turbulent boundary layer, etc.
- Perform 2D, 3D and axisymmetric analysis with linear and quadratic elements
- Predict noise caused by turbulent flows retrieving aeroacoustic sources from steady or unsteady CFD results (SNGR technique, Lighthill and Möhring analogies)
- Interface with CFD codes using native CFD file format
- Low, mid, and high-frequency capabilities relying on Finite Elements and Virtual SEA approaches
- Dedicated workflows for pass-by noise, electric motor noise and more, in the Actran Workflow Manager
- GPU acceleration for large domains, high frequency problem solving

MSC CoSim

Where multiphysics gets real

Co-simulation provides engineers with a unique, more complete & holistic performance insight by coupling together multiple simulation disciplines. Everything from acoustics to multibody dynamics (MBD), to Computational Fluid Dynamics (CFD), to structural analysis, and explicit crash dynamics can be connected thanks to MSC CoSim. Depending on the type of analysis, engineers can use Hexagon's solutions in two ways – Co-Simulation (applying multiple physics to the model simultaneously) or Chained Simulation (passing load case results from one analysis to the next).

MSC CoSim engine

The MSC CoSim engine has been developed to provide a co-simulation interface for the direct coupling of different solvers/disciplines with a multiphysics framework. The current version, MSC CoSim 2022, enables engineers to set up co-simulation models between Adams, Marc, MSC Nastran, scFLOW and scSTREAM.

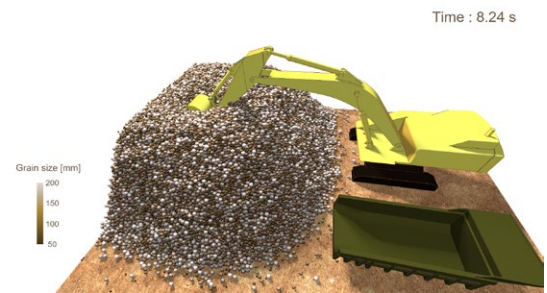

Other open co-simulation solutions

Besides the CoSim engine, Hexagon also supports a list of other co-simulation methodologies, including the Functional Mock-up Interface (FMI), Adams Marc Co-Simulation Interface (ACSI) and so on.

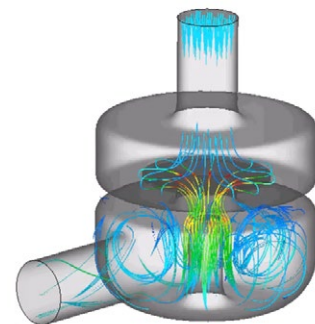

Chained simulation

Chained simulation allows CAE engineers from different departments to integrate multiple disciplines sequentially and improve the overall simulation accuracy. For example, passing the road loads data from an Adams Full Vehicle model to the downstream MSC Nastran model for the stress & durability analyses.

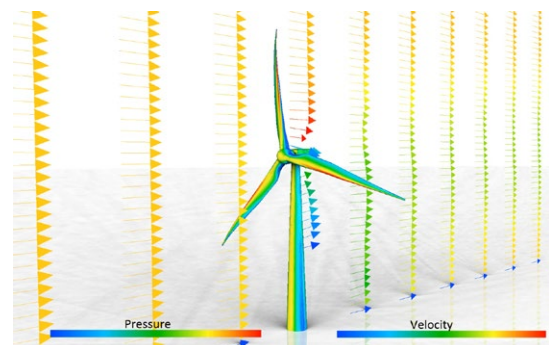

Cradle CFD

Multiphysics focused computational fluid dynamics software

Cradle CFD offers a practical, state-of-the-art computational fluid dynamics, CFD, simulation and visualization software solution. Embracing remarkable processing speed, refined technology, and proven practicality verified by high user satisfaction, it has been in use for diverse applications, such as Automotive, Aerospace, Electronics, Building and Architecture, Civil Engineering, Fans, Machinery, and Marine developments, to solve thermal and fluid problems. Incorporating Multiphysics co-simulation and chained simulation capabilities to achieve couplings with Structural, Acoustic, Electromagnetic, Mechanical, One-Dimensional, Optimization, Thermal Environment, 3D CAD and other analysis tools that allow users to efficiently solve engineering problems spanning multiple disciplines. The powerful award-winning postprocessing capabilities to generate visually powerful simulation graphics to easily convey simulation data, Cradle CFD enables users with any skill level to process advanced simulations and gain valuable insights into their designs. Cradle CFD solution consists of the following products:

scFLOW

scFLOW is a next-generation CFD tool that uses unstructured mesh to accurately represent complicated geometry. With a streamlined workflow, the Preprocessor aids users to generate high-quality polyhedral mesh elements and construct complicated models and the Solver ensures more stability and speed, scFLOW can solve aerospace and automotive aerodynamics, hypersonic flow, performance of fans, pumps and other rotating equipment, design problems of electronic devices, multiphase phenomena, marine propeller cavitation, and varied problems effectively. Through co-simulation and chained simulations coupled with Hexagon's Marc, MSC Nastran, Adams and Actran, more realistic coupling and multidisciplinary analyses with fluid, structure, acoustics, and multibody dynamics can be achieved.

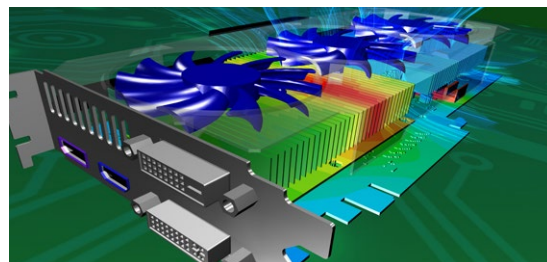
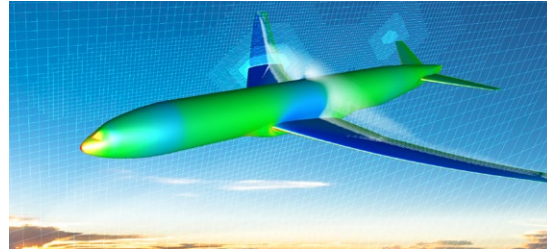
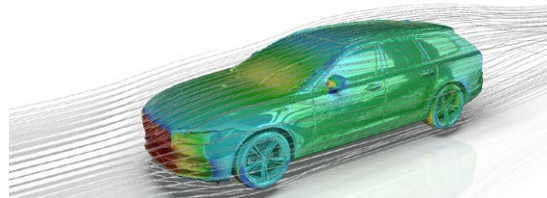

scSTREAM

scSTREAM is a general-purpose CFD tool that uses Cartesian or cylindrical structured mesh to enable easy mesh generation and high-speed simulations to be performed in a fraction of the time of other solutions. Due to the meshing nature and analysis system that enables large-scale calculation, scSTREAM excels at processing extensive simulations, where users are required to solve engineering problems such as thermal problems of electronic devices and indoor environment, wind flow, and heat island phenomena.

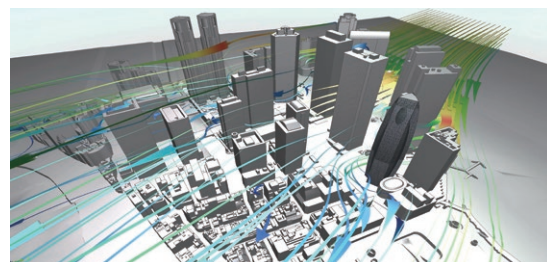

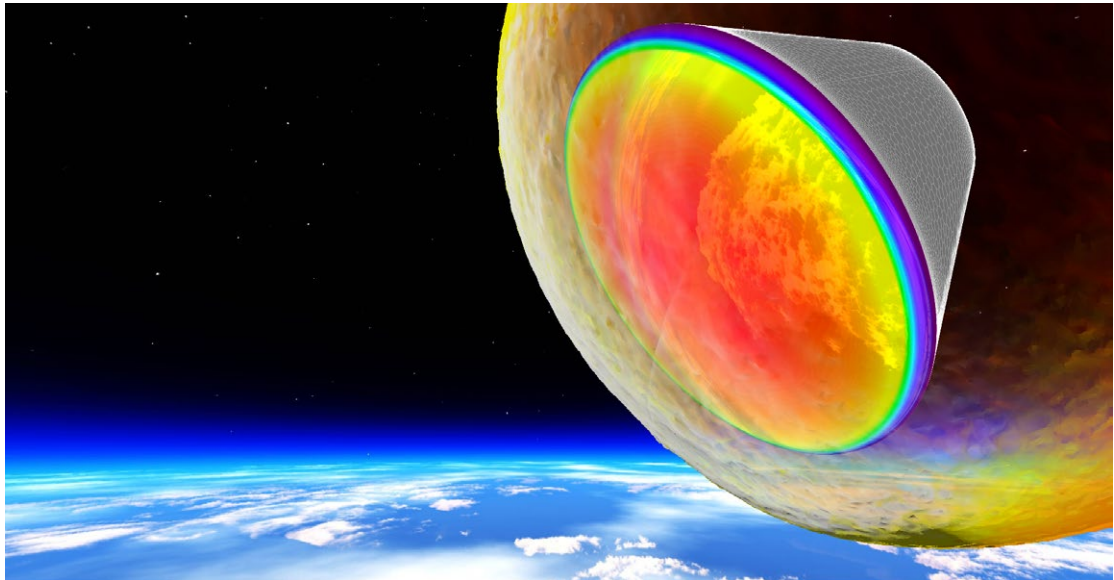

scPOST

scPOST is a comprehensive and versatile data visualization software empowering novice and expert users to instantly create a rich view of design performance.

It has the capability for a sharable light-weight format that supports extended reality, XR, (virtual reality, augmented reality, and mixed reality) for a more immersive data visualization experience.

In addition to fluid dynamics results, it also supports other simulation results from Actran, Adams, MSC Nastran and Marc all in one visualization solution.

HeatDesigner

HeatDesigner is a structured (Cartesian) mesh thermal fluid analysis software specially designed for electronics cooling thermal analysis. It uses core technology from Hexagon's scSTREAM general-purpose structured mesh thermal-fluid software product.

HeatDesigner's performance is optimized for applications that do not require precise reproduction of fine geometrical curvature to predict an accurate flow field. However, HeatDesigner is capable of accommodating meshes with over 2 billion elements enabling it to capture fine geometrical details. Like scSTREAM, the major advantages of HeatDesigner are fast calculations times and low memory consumption.

Capabilities

- Import native data from major 3D CAD software as well as most generalized intermediate data formats (Parasolid XT, STEP, and others)
- Capable of solving compressible (density-based solver), hypersonic (hypersonic solver), and incompressible (pressure-based solver) flows
- Account for thermal radiation effects by VF and FLUX methods
- Discontinuous mesh, overset mesh, moving object functions to enable evaluating object rotations and motions, as well as flow and heat generated as a result
- Able to evaluate 6 degree-of-freedom motion, where a rigid body is passively translated or rotated by fluid force
- Free surface function to calculate interface geometry between gas and liquid
- Perform multiphase analysis to evaluate heat conduction, heat transfer, latent heat, phases changes such as boiling & condensation, and solidification & melting,
- Calculate humidity and dew condensation caused by temperature changes and evaporation/transferring moisture within solid
- Assess cavitation and possible erosion on propeller rotating at high-speed underwater
- Perform multiphase analysis using DEM (Discrete Element Method) that enables coupling of fluid and flow analysis of particles
- Simulate particle behaviour affected by diameter size, density, falling speed, and interaction between particles and fluids
- Account for liquefaction at adhering on the wall surface
- Consider external force and effects of an electrostatic field on charged particles
- Import wiring patterns such as Gerber and IPC-2581 data generated by electronic CAD to generate a model
- Convert results on temperature changes acquired by transient heat resistance measurement into structure function (thermal resistance – heat capacity characteristics) to accurately generate a thermal model
- Illuminance analysis to evaluate and consider directivity effects on the brightness of objects, where natural daylight and artificial lighting is cast
- Refer to climate data (ASHRAE and NEDO) to analyse solar radiation, where the position of the Sun is automatically calculated by longitude, latitude, and date
- Thermoregulation model (JOS) to analyse temperature and humidity changes of the human body and surrounding environment
- Estimate comfort level (PMV and SET*), degree of heat stress (WGBT), and ventilation (SVE)
- Mapping function minimizes calculation load by applying a wide range of its surrounding area as boundary conditions
- Cradle XR, Light-weight viewer application with support for extended reality (virtual reality, augmented reality, and mixed reality) that allow users to easily access and share simulation data
- Rich set of automation API that allows users to highly automate workflows, democratizing Cradle CFD solutions to non-expert users
- Award-winning, powerful visualization postprocessing capabilities

Digmat

The multiscale material modelling platform

Materials are used everywhere across multiple industries, ranging from automotive and aerospace to electronics and medical applications. By leveraging materials usages at their full potential, Digmat enables to drive materials innovations and lightweight product designs, and reduce materials waste to create a significant and sustainable impact.

Virtual material engineering & testing

Based on a multiscale material modelling technology, Digmat enables to predict the multiphysics performances of complex materials such as composite materials, reinforced plastics, foams, metallic materials and many more. The creation of material digital twins provides scientists and engineers with an accurate understanding of the material behaviour. Different materials and microstructures can be virtually tested to efficiently screen the materials for an optimised performance and accelerate the material selection and development

- Digmat-MF computes the macroscopic properties of multiphase materials based on the mean field homogenization approach that provides fast and accurate results.
- Digmat-FE generates a representative volume element (RVE) of the material microstructure. The finite element analysis of the RVE allows to gain an in-depth view into composites.
- Digmat-VA enables to virtually define a test matrix to characterise composite laminates while considering the material, process and testing related variability.

Integrated computational materials engineering (ICME)

The ICME approach enables to enrich CAE analyses by connecting the manufacturing process, material properties and part performance. The manufacturing process induces local microstructures, residual stresses, defects, etc. that are captured in the design simulations to make them more predictable and reliable. Most of the manufacturing processes are supported, including injection and compression moulding, draping, thermoforming and additive manufacturing processes among others. This holistic solution allows to design lightweight components with confidence while reducing the development time and cost.

- Digmat-MX provides access to the ecosystem of material suppliers with an extensive database of material cards. The tool also allows easy and fast calibrations of new material cards based on limited experimental data.
- Digmat-MAP allows to transfer manufacturing data from a processing mesh to a structural mesh with a high versatility in supported data and formats.
- Digmat-CAE interfaces with structural FEA solvers to couple material cards and manufacturing data in integrative simulations.
- Digmat-RP is a comprehensive solution that enables to consider the process-induced material microstructure in the finite element analysis of the component.

Polymer Additive Manufacturing

Digmat offers the unique solution for polymer additive manufacturing that combines material modelling, process manufacturing and part performance. The behaviour of high-performance printing materials can be analysed and warpage compensation strategies can be adopted to overcome manufacturing issues. Integrated within the ICME approach, the productivity and reliability of printed parts are maximized.

- Digmat-AM simulates and optimises the selective laser sintering (SLS), fused deposition modeling (FDM), fused filament fabrication (FFF) processes of polymers and composites.

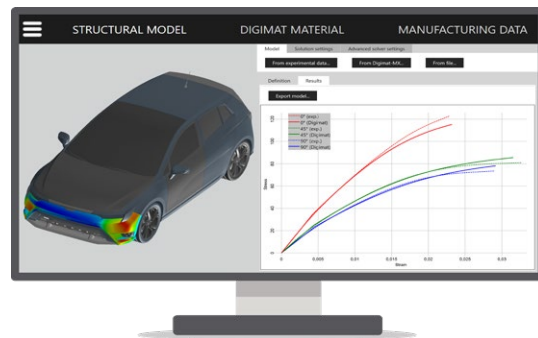
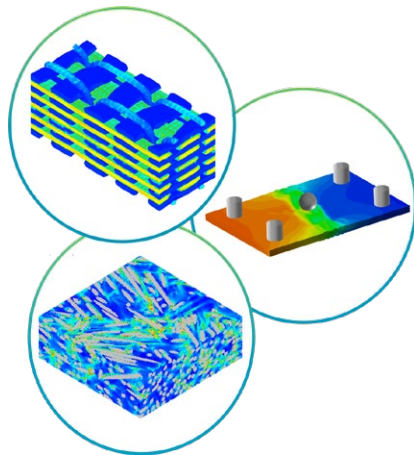

Capabilities

- Advanced and multiscale material modelling, providing access to extensive libraries of material models, microstructures, physics, and tests
- Sensitivity analyses to study, understand and optimise materials and microstructures
- Interfaces with most of the manufacturing process software and structural FEA solvers
- Comprehensive and advanced solution for reinforced thermoplastics parts manufactured by injection moulding, including fibre orientation estimations and targeting all key performances such as static, crash, creep, durability, NVH etc.
- Additive manufacturing process simulations for polymers and composites, predicting warpage, residual stresses, temperature fields, crystallinity evolutions, layer adhesion, porosity, cost estimates etc.

Benefits

- Materials by design to accelerate material innovations and innovate with materials
- Reduce the time-to-market of new products and parts with more predictive analyses
- Actively contribute to your sustainability objectives by designing lightweight and more reliable products while consuming less materials for tests and qualifications
- Anticipate manufacturing issues and improve quality

Easy5

Advanced controls and systems simulation

Engineering aircraft, vehicles, agricultural equipment, and other complex systems requires a systems-engineering approach in which not only the components and sub-systems, but the entire system as a whole is tested. Traditional ‘build and test’ methodologies are time-consuming and expensive; and now more than ever, every industry is challenged to meet the conflicting requirements of increasing innovation while reducing cost and time to market.

Easy5 provides accurate, reliable multi-domain modeling and 1d simulation of dynamic physical systems. Using Easy5, some of the most respected companies in the world are evaluating system level performance with CAE to reduce physical prototypes, cut cost, and accelerate their product development process.

Dynamic systems: those systems whose behaviour as a function of time is important, are typically defined using first-order differential (or difference) equations. Easy5 simplifies the construction and analysis of such systems by means of a graphical, schematic-based application, offering a comprehensive set of pre-packaged “components”, stored in application-specific libraries, to simplify the assembly and simulation of such systems. Systems engineers work within a familiar schematic drawing environment to add and specify simple, yet complex, connections between components in an intuitive, simple-to-use, multi-level hierarchical modeling environment.

Typical applications of Easy5 include control systems, hydraulics (including thermal effects), pneumatics, gaseous flow, thermal, electrical, mechanical, refrigeration, environment control, lubrication or fuel systems, and sampled-data/discrete-time behaviour.

Easy5 has 5 Application Package Libraries:

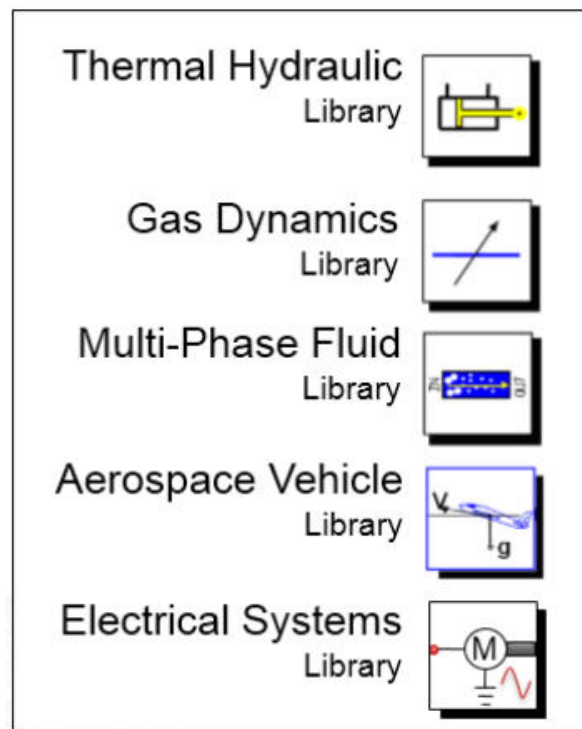

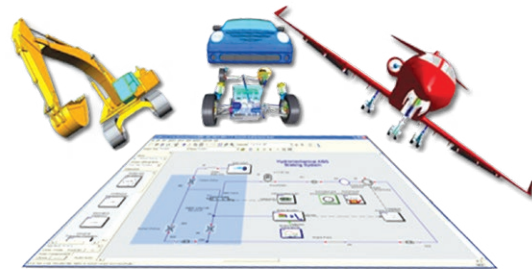
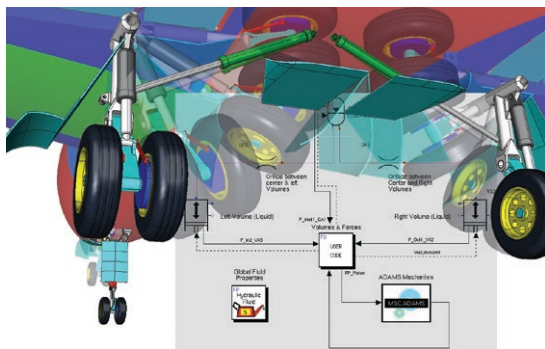

Capabilities

- Assemble models easily from hundreds of pre-built system components
- Easy to use schematic based 1d system-level modeling, simulation, and analysis
- Complete system virtual prototyping by linking Easy5 to other MSC applications
- 64-bit support for Windows and Linux
- Integration with SimManager for easy sharing of models and results (Windows only)
- Customizable libraries of components
- Easy to use GUI with Windows style functionalities
- Integration with other CAE software packages like Adams, MSC Nastran and Simulink®
- FMI (Functional Mock-up Interface) Support for easier co-simulation

Benefits

- Asses complex multi-domain systems quickly and accurately
- Improve products early in the design process
- Understand problems and design countermeasures effectively
- Reduce CAE cost with shareable libraries
- Improve CAE effectiveness by integrating with other tools

Marc

Advanced nonlinear simulation solution

Marc is a powerful, general-purpose, nonlinear finite element analysis solution to accurately simulate the response of your products under static, dynamic, and multi-physics loading scenarios. Marc's versatility in modeling nonlinear material behaviours and transient environmental conditions makes it ideal to solve your complex design problems.

- Nonlinear and multiphysics solution schemes: Solve problems spanning the entire product lifespan, including manufacturing process simulation, design performance analysis, service load performance and failure analysis with robust nonlinear algorithms and multiphysics capabilities that include coupled thermomechanical analysis, electromagnetics, piezoelectric analysis, electrical-thermal-mechanical, electrostatics and magnetostatics coupled with structural response and more.
- Nonlinear materials: Choose from an extensive library of metallic and non-metallic material models, along with a library of nearly 200 elements for structural, thermal, multiphysics and fluid analyses.
- Failure and damage analysis: Investigate damage and failure using models suited for several material classes, including ductile, brittle, composites, elastomers, and concrete. Study crack propagation to avoid catastrophic structural failures.
- Contact analysis: Easily set up a contact model, analyse and visualize the ever-changing component interaction. Account for friction and plasticity generated heating in a coupled analysis.
- Automatic remeshing: Use local and global adaptive remeshing capabilities to overcome problems due to high stress gradients and/or large element distortions.
- Parallel processing: Achieve higher productivity with the time-tested parallel analysis capabilities. Take complete advantage of the multi-core processors and the GPUs available on their systems, to achieve higher performance.
- Integrated pre-/post-processing: Create and analyse complex models with an integrated user interface designed expressly for nonlinear analysis. Customize the application with Python scripting language to automate repetitive tasks across the entire simulation process.

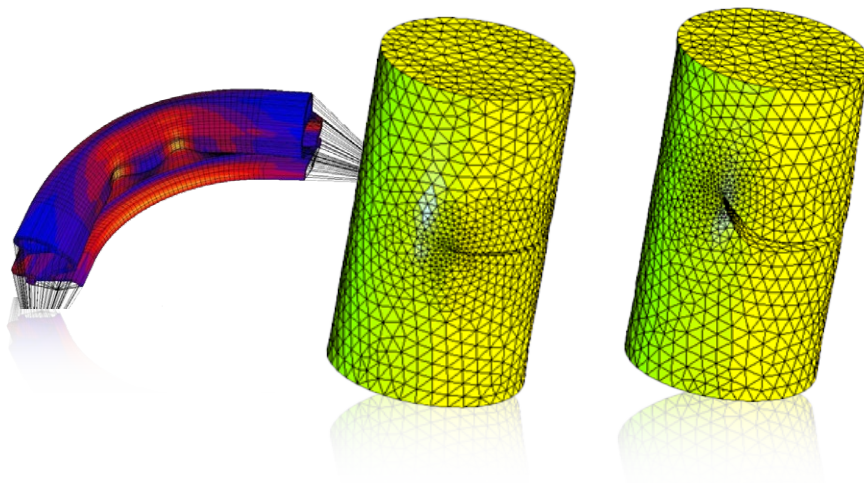

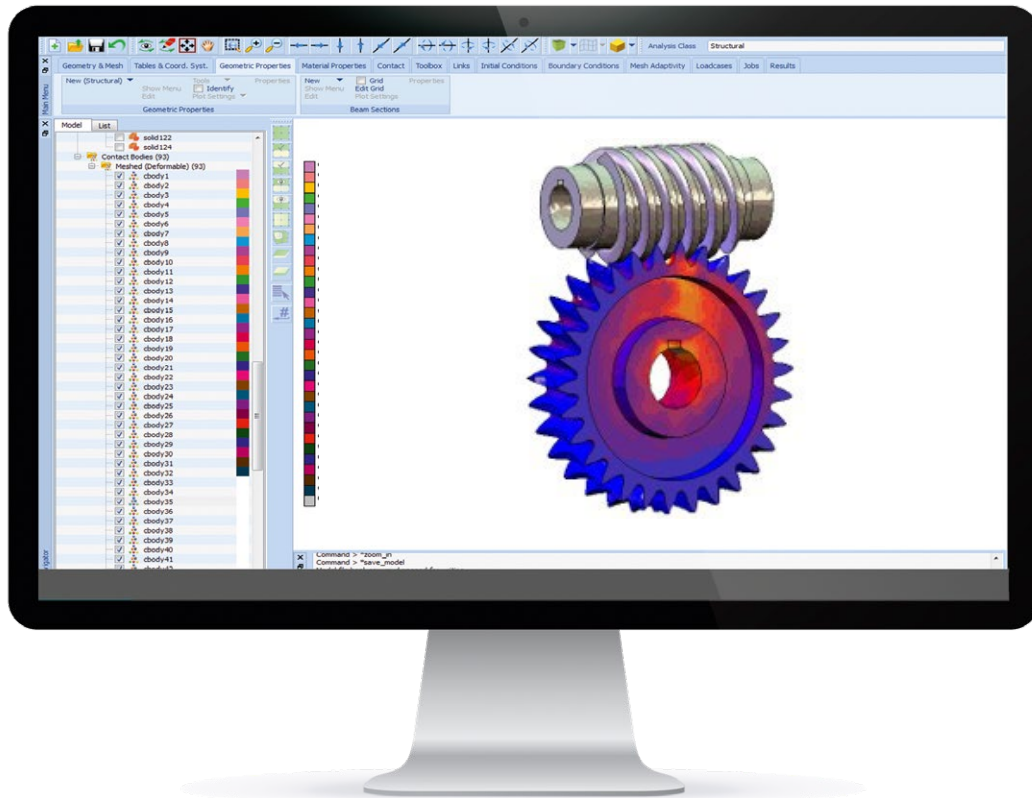

Capabilities

- Advanced nonlinear materials
- Industry proven contact to accurately simulate product performance and manufacturing
- Coupled solutions of nonlinear structural, thermal, electromagnetics.
- Advanced heat transfer analysis capabilities
- Special purpose material models including Shape Memory Alloy and Solder models
- Comprehensive connector and fastener models to simulate commonly found connections
- State-of-the-art iterative solvers and parallel processing on shared and distributed memory machines
- Automated remeshing and adaptive meshing to increase solution robustness and accuracy
- Advanced damage and fatigue analysis of metals and composite structures
- Predict crack initiation and propagation under realistic load conditions

Benefits

- Robust solver technology that greatly enhances the value of nonlinear solutions encountered in many industries
- Shorten the design optimization process, while improving design and product performance through integrated simulation
- Reliable analysis capabilities to reduce product design, development, manufacturing, and warranty costs



Simufact

Virtual manufacturing for metalworking industry

Simufact is a leading FEA based simulation solution provider for metal forming, mechanical joining, welding, metal-based additive manufacturing, and subtractive manufacturing such as milling and drilling. With the ability, on the one hand, to simulate the entire conventional manufacturing process chain, starting from blanking, shearing of wires or billets, to multi-stage forming, punching, trimming, and heat treatment followed by joining operations, welding, machining, and structural analysis. On the other hand, the entire metal additive manufacturing process chain can be simulated and optimised, starting with powder bed fusion or metal binder jetting, heat treatment, cutting, support removal and machining. Simufact helps optimise the manufacturing processes, and reduce costs and time-to-market, while improving product quality.

The Simufact software solutions are divided into three product lines that have been developed for the specific requirements of each individual processes: Simufact Forming, Simufact Welding and Simufact Additive:

Simufact Forming

Simufact Forming is an established software solution for the simulation of metal forming manufacturing processes. The software covers all essential areas of forming technology: forging, cold forming, sheet metal forming, all major incremental processes and mechanical joining. Simufact Forming provides support in microstructure simulation, calculation of die load, material flow and prediction of material properties during conventional and inductive heat treatment. Furthermore, thermo-mechanical joining methods of pressure welding are also supported.

Simufact Welding

Simufact Welding is used for modelling and optimising a wide range of fusion and pressure welding processes, considering weld sequence and clamping. Processes such as arc welding, laser beam welding, electron beam welding, brazing, resistance spot welding as well as the generative manufacturing process 'Direct Energy Deposition' (DED or WAAM) can be modelled in Simufact Welding. Additionally, Simufact Welding can be used to model the heat treatment, different variants for cooling and unclamping as well as the mechanical load on welded structures.

Simufact Additive

Simufact Additive is a scalable software solution for the simulation of metal-based additive manufacturing processes which focuses on powder bed melting (L-PBF) and metal binder jetting (MBJ) processes. Simufact Additive is a software solution designed to predict and compensate for distortion, residual stress and temperature distribution throughout the printing, heat treatment, cutting, hot isostatic pressing (HIP) as well as machining processes virtually before the part is manufactured by the 3D metal printer.

Additional modules are available for all Simufact software solutions to help with microstructure calculations, faster performance, additional CAD import interfaces, customisation, and access to material databases.

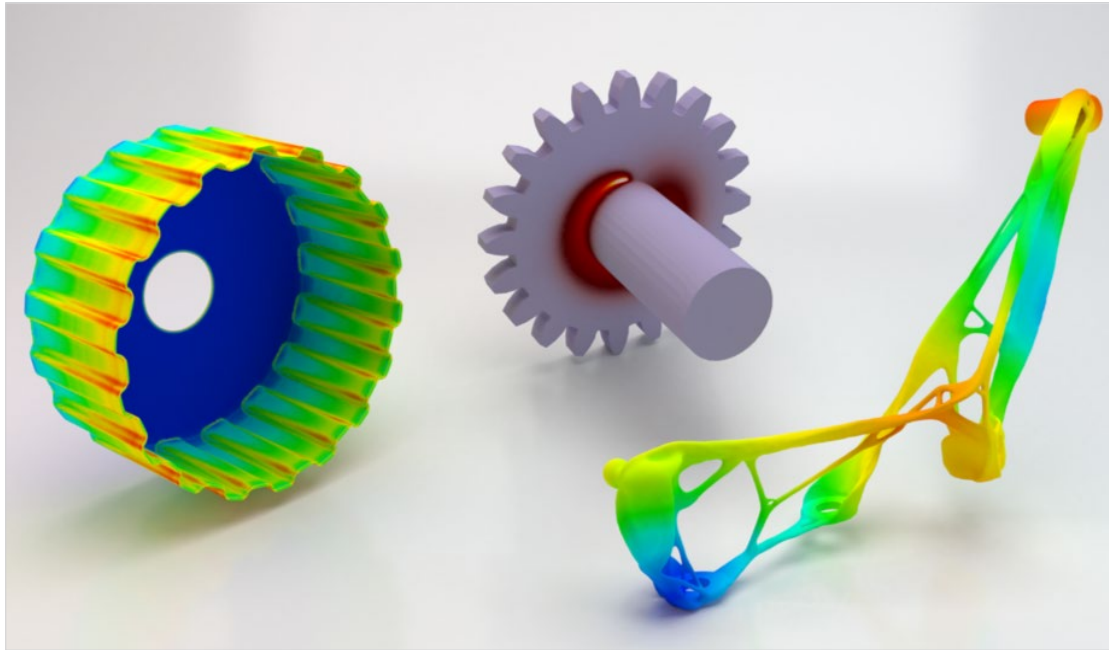

Capabilities

- Best-in-class solution for manufacturing processes
 - Forming applications,
 - Joining & welding applications, and
 - 3D-metal-printing applications.
- One single pre- and post-processing environment specifically for manufacturing processes.
- Accurate prediction of component properties during and after the manufacturing process chain through highly accurate material description.
- Powered by MARC / Dytran – the world’s leading non-linear solvers – able to solve simple to the most advanced manufacturing problems.
- Open architecture for easy and seamless results import & export through UNV data format.

Benefits

- First-class result accuracy at highest speed and stability, which can be adjusted either faster or more accurately due to scalability.
- Simple process-oriented setup of the process with all relevant manufacturing process stages and full interoperability to simulate an entire process chain.
- No expert knowledge required, as the software solution is designed to be user-friendly, intuitive and process oriented.
- Virtually design and optimise your manufacturing process to ensure manufacturability and save materials, time, and money.
- Supported by a team of manufacturing experts.

MSC Nastran

Multidisciplinary structural analysis

MSC Nastran is the world's first FEA structural analysis code that is still the gold standard in a wide range of industries and applications today. It is a multidisciplinary structural analysis application used by engineers to perform static, dynamic, and thermal analysis across the linear and nonlinear domains, complemented with automated structural optimization and award-winning embedded fatigue analysis technologies, all enabled by high performance computing. MSC Nastran is the most trusted solution in the industry. MSC Nastran's predictions are the most consistent and accurate in the industry. Engineers get "right results every time" using MSC Nastran.

Manufacturers leverage MSC Nastran's unique multidisciplinary approach to structural analysis at various points in the product development process. MSC Nastran may be used to:

- Virtually prototype early in the design process, saving costs traditionally associated with physical prototyping
- Remedy structural issues that may occur during a product's service, reducing downtime and costs
- Optimize the performance of existing designs or develop unique product differentiators, leading to industry advantages over competitors.

MSC Nastran is based on sophisticated numerical methods, the most prominent being the Finite Element Method. Nonlinear FE problems may be solved either with built-in implicit or explicit numerical techniques.

MSC Nastran advantages

- Multidisciplinary Structural Analysis: To build up a comprehensive level of engineering analysis capability, multiple software solutions must be acquired, and users must be trained with each new tool. MSC Nastran features multiple analysis disciplines, enabling customers with one structural analysis solution for a wide variety of engineering problems.
- Structural Assembly Modeling: One structural member is rarely analysed independently. Structural systems consist of numerous components and must be analysed. MSC Nastran features several methods to join multiple components for system level structural analysis.
- Automated Structural Optimization: Design optimization is a critical element in product development but is often very iterative and requires a great deal of manual effort. MSC Nastran includes optimization algorithms that automatically seek optimal configurations in an allowed design space.

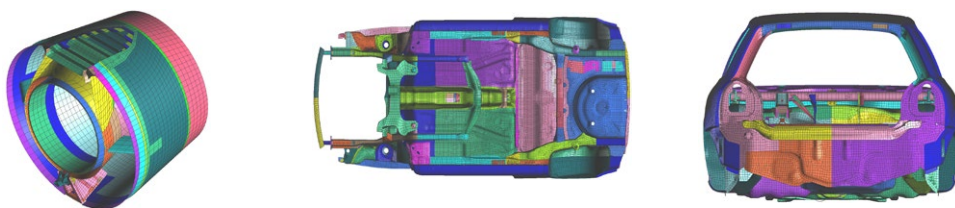

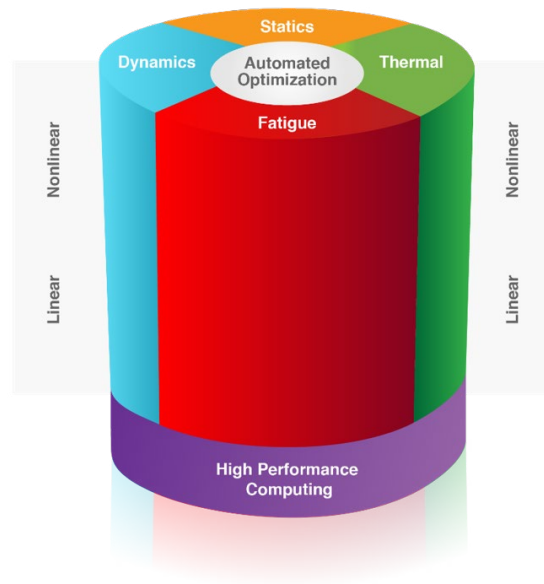

Benefits

Multidisciplinary structural analysis

- Use one platform to perform linear or nonlinear analysis for the following disciplines: static, dynamic (NVH and Acoustics included), thermal, and buckling, and reduce the dependency on multiple structural analysis programs from various vendors
- Perform fatigue analysis with embedded fatigue technologies and reduce the time usually associated with fatigue life determination
- Assess the behaviour of advanced composites and fiber reinforced plastics with built in Progressive Failure Analysis and User Defined Services for Mean-field Homogenization coupling with Digimat

Structural assembly modeling

- Expedite meshing with Permanent Glue, enabling you to connect incongruent meshes that would traditionally require time consuming mesh transitions
- Save time constructing assemblies that consists of welds or fasteners via specialized connector elements
- Speed up the re-analysis of large assemblies by constructing Superelements, and optionally, share Superelements with other manufacturers while concealing confidential design information
- Perform contact analysis and determine contact stresses and contact regions in multi-component designs

Automated structural optimization

- Optimize for stress, mass, fatigue, etc. while varying design variables such as material properties, geometric dimensions, loads, etc.
- Enhance the shape or profile of structural members with shape optimization
- Find optimal composite laminate ply thicknesses with topometry optimization
- Determine optimal bead or stamp patterns for sheet metal parts with topography optimization
- Remove excess and unnecessary volume with topology optimization
- Simultaneously optimize multiple models across disciplines with Multi Model Optimization

Dytran

Explicit dynamics and fluid structure interaction

Dytran is an explicit finite element analysis (FEA) solution to simulate short-duration events like impact and crash, and to analyse the complex nonlinear behaviour that structures undergo during these events. Dytran enables engineers to study the structural integrity of designs to ensure that final products meet customer safety, reliability, and regulatory requirements.

Dytran is an established explicit 3D solver, proven in metal forming, and Dytran provides excellent support for shell elements and contact approaches typically employed in sheet metal forming simulation. FASTIncremental, FTI FormingSuite's virtual manufacturing solution for die designers and tooling engineers now comes standard with the Dytran solver.

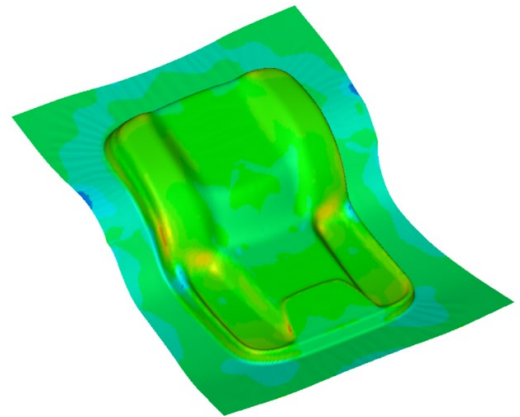

Dytran delivers structural, material flow and coupled FSI analysis capabilities in a single package. Using a unique coupling feature that enables integrated analysis of structural components with fluids and highly deformed materials in one continuous simulation, Dytran provides realistic solution to complex problems.

- Transient structural analysis: Using explicit solver technology, Dytran provides faster solution to large, complex transient dynamic problems. Users can use from a wide variety of elements that include solid, shell, beam, membrane, connectors, and rigid elements, to model the structures.
- Nonlinear materials: Select from a wide range of material models to model the nonlinear response and failure. The available material models include linear elasticity, yield criteria, equations of state, failure and spall models, explosive burn models and composite materials to name a few.
- Contact analysis: Model interaction between multiple parts and assemblies with robust contact analysis capability. The interaction may include frictionless contact, sliding with frictional effects and separation. Single surface contact can also be used to model buckling of structures where structures may fold onto themselves.
- Fluid-structure interaction: Analyse fluid behaviour and its effects on structural response in a single model with the help of a combination of Lagrangian and Eulerian solvers in Dytran. Interaction between the fluids and structures is achieved through a coupling surface created on structures.
- High performance computing: Achieve higher productivity by taking advantage of the latest numerical methods and high-performance computer hardware. Analyses can be run on a broad range of machines including desktop computers to supercomputers. Users can also benefit from the parallel processing capabilities to achieve faster solutions.

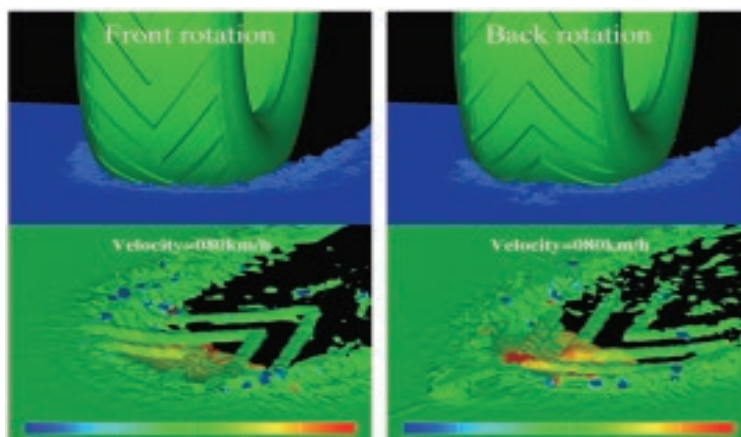

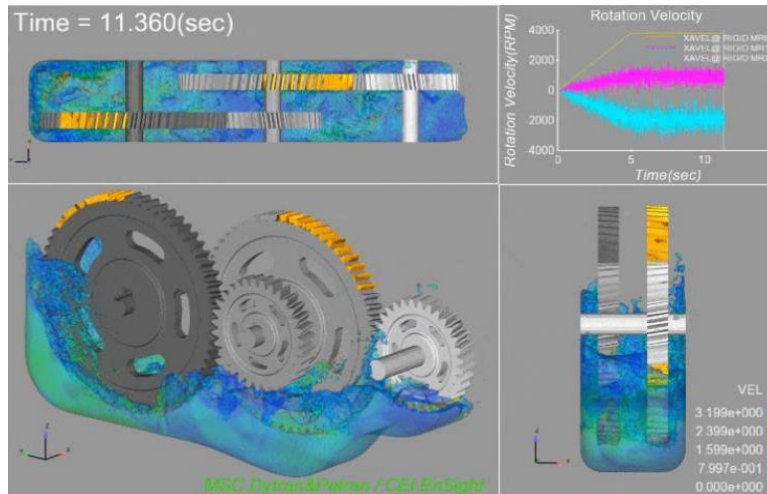

Capabilities

- Advanced, explicit nonlinear solver technology for simulating and analysing extreme, short duration dynamic events.
- Robust and efficient three-dimensional contact and coupling algorithms using Lagrangian finite element method for structural analyses and Eulerian finite volume method for fluids and multi-material flow analyses.
- Complete finite element model library that includes beams, shells, solids, springs, and dampers with large displacement formulation.
- Full range of nonlinear material models for metals, composites, soils, foam rubber, liquids, and gases.
- Distributed Memory Parallel (DMP) support for Eulerian solver and coupling surface computation

Benefits

- Minimize the costs of physical prototyping and eliminate redundant test cycles through Dytran's streamlined modeling flow and most advanced fluid-structure interaction (FSI) simulation capabilities.
- Quickly obtain detailed insight into the nonlinear, dynamic behaviour of real-world problems that cannot be easily solved with other simulation tools.
- Model complex scenarios and perform "what-if" analyses earlier in the design cycle within a single analysis package and simulation environment.
- Apply results from Dytran to improve the quality of your products and minimize the probability of failures and costly redesigns.

Volume Graphics



part of Hexagon

Comprehensive real-world data as a basis for MSC simulation

Volume Graphics enables its customers to keep the quality high by getting full insight into their products—from design to serial production. Founded in 1997 and headquartered in Germany, the company has more than 20 years of experience in the development of software for non-destructive testing based on industrial computed tomography (CT). Since 2020, Volume Graphics has been part of Hexagon.

Volume Graphics applications such as the comprehensive CT analysis software VGSTUDIO MAX cover all needs related to metrology, defect detection and assessment, material properties, whether a customer is using the all-encompassing technology of CT or other 3D data formats such as point cloud, mesh, and CAD. Thanks to its modular concept, VGSTUDIO MAX evolves with the needs of the customer. And with VGINLINE, a ready-to-use framework that relies on the advanced capabilities of VGSTUDIO MAX, customers can semi- or fully automate their quality control process.

CT data provides the basis for the insightful results the Volume Graphics software delivers, as CT non-destructively reveals every aspect of an object. Because CT reconstruction produces a complete representation of an object in 3D from many 2D X-ray images, software such as VGSTUDIO MAX allows the user to draw conclusions on the external and internal structures of the object and its material properties. Thus, the user gets answers to more complex questions. Moreover, the technology of CT is uniquely positioned to fuel simulations with real-world data. In the end, customers can improve their simulations and validate results—all by using CT data analysed with Volume Graphics software.

The **Digital Volume Correlation Module** offers superior support for finding damage in materials using a voxel-based before-after comparison, making it possible to easily export strain tensors with respect to your FEM mesh to validate your FEM simulations.

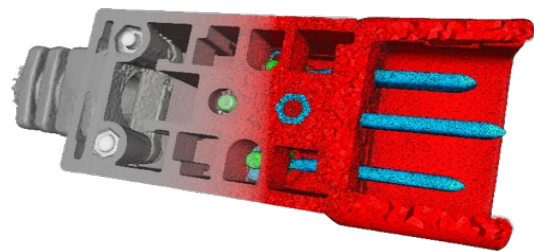
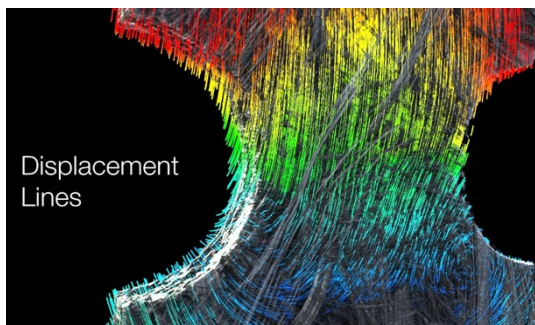

Use the **Volume Meshing Module** to create accurate and high-quality tetrahedral volume meshes from your CT scans which you can then use for mechanical, fluid, thermal, electrical, and other FEM simulations.

Learn more at: [volumegraphics.com](https://www.volumegraphics.com)

CAEfatigue

FE-based random response and durability simulation

CAEfatigue is a FE-based random response and fatigue solver that has rapidly become the analysis tool of choice for random response and fatigue life calculations for static or dynamic problems in both the time domain and frequency domain. Testing against repeated loading cycles, sometimes millions of times over, is often too expensive and time consuming to be practical. Finite element analysis programs can tell you where stress “hot spots” exist, but on their own cannot tell you whether those hot spots are critical areas for fatigue failure, when fatigue might become a problem and how to possibly fix those problems. Many manufacturers simply accept long prototype-development cycles, overweight components, unpredictable warranty claims, and loss of customer confidence. CAEfatigue enables durability engineers to predict how long products quickly and accurately will last under any combination of time-dependent or frequency-dependent loading conditions. Benefits include reduced prototype testing, fewer product recalls, lower warranty costs, and increased confidence that your product designs will pass required test schedules.

CAEfatigue also offer the User the ability to calculate random response for displacements, velocities, accelerations, forces and to use that ability to detect “rattle” conditions (i.e., if parts might hit under random loading), to transfer or cascade loading from one area of the model to another and to even develop less complicated surrogate loading that can replace multi inputs with single inputs, which is especially useful for testing components and parts. The advanced random response and life estimation capability of CAEfatigue allows users to perform comprehensive random response and fatigue analysis with the same FE model setup that is used for stress analysis. The environment seamlessly enables CAE, dynamic analysis, and durability to be managed in one user friendly interface.

Modules

CAEfatigue is packaged in 3 configurations that you can choose from based on your analysis needs.

- **CAEfatigue TIME:** This package is used to calculate static and dynamic time domain durability and fatigue damage using results from Nastran, Ansys and/or Abaqus. This package includes a Graphical User Interface (GUI) for Microsoft Windows™. This package also includes the Loads Scheduler toolset for graphically developing time-based input loading from block loading, deterministic waves (i.e., sine, square, triangle, sawtooth), sine sweeps, XY pairs, etc.
- **CAEfatigue FREQUENCY:** This package includes TIME and is used to calculate static and dynamic frequency domain random response and fatigue damage from Base Shake (single input) or Multi input loading using system properties (transfer functions) from a variety of different solvers (e.g., Nastran, Abaqus, Ansys). This package also includes the TIME2PSD toolset for converting time domain data into frequency domain PSD matrix file.
- **CAEfatigue PREMIUM:** This package includes FREQUENCY and is used to calculate time and frequency domain random response and fatigue damage. It also includes advanced random outputs like displacements, velocities, accelerations, and forces, allows for the use of standalone deterministic loading or mixed deterministic loading with random loading and allows for the calculation of surrogate loads and the use of spot / seam / User welds in the time domain and frequency domain.

The product is available within MSC ONE, as a standalone software or within MSC Nastran.

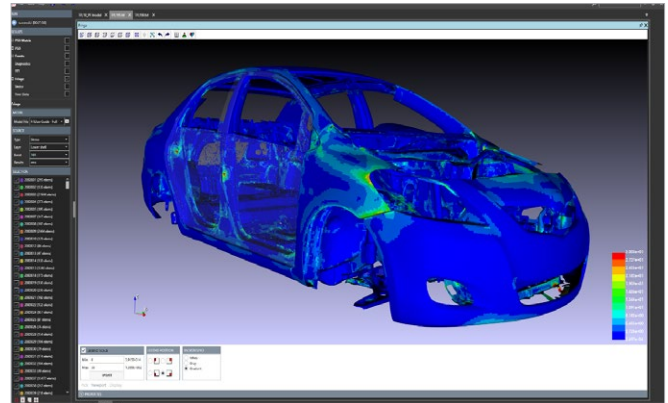
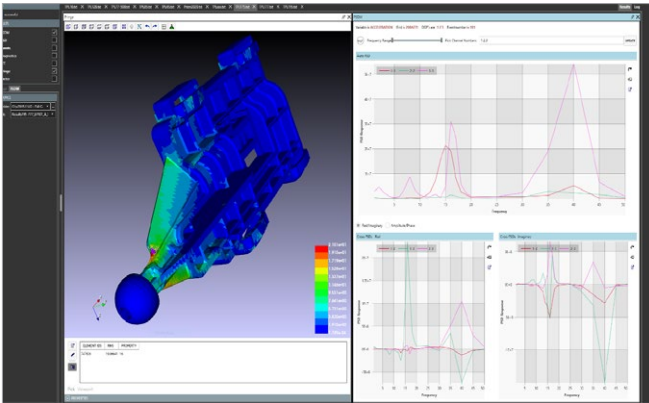

Capabilities

- Processing times are super-fast due to advanced “Running Sum Technology” with no limits on the size of the model being analysed or loading being applied.
- For a frequency domain analysis, the software can use any number of random loads with or without deterministic loads (i.e., random only, sine-on-random, sine only, sine sweep, harmonic sines, etc.). The software can be used to detect collisions between parts under random loading (Rattle detection), can be used to cascade input loads to other parts for further analysis and can be used to optimize loading to reduce complexity, i.e., reduce a multiple input PSD loading to a single input PSD loading or even a single sine wave.
- For a time, domain analysis, the software can do quasi static, full transient or use modal participation factors. Will also support non-linear stress inputs from Nastran and Marc.
- Comes with time signal to PSD conversion toolset (TIME2PSD), which is a powerful conditioning and conversion tool for converting multi-channel, multi event time domain data into a direct and cross PSD matrix of loading.
- Comes with a time signal generation toolset (Load Scheduler) for generating time-based loading from existing RPC or CSV files with or without additional loading from block loading, deterministic waves (i.e. sine, square, triangle, sawtooth), sine sweeps, XY pairs, etc. The defined loading can be exported as separate Events in RPC / RSP / CSV / TXT or TABLED1 (BDF) format.
- Can do spot and seam weld analysis in both time domain and frequency domain. Additionally, can do User specified weld shapes in frequency domain.
- Can be used for both high-cycle fatigue and low-cycle fatigue.
- Can be used with both stress life (S-N) and strain life (e-N) material data in the same analysis.
- Comes with modifiable materials database with comprehensive set of S-N, E-N, Cyclic and component curves.

Patran

Complete FEA modeling solution

Patran is the world's most widely used pre/post-processing software for Finite Element Analysis (FEA), providing solid modeling, meshing, analysis setup and post-processing for multiple solvers including MSC Nastran, Marc, Abaqus, LS-DYNA, ANSYS, and Pam-Crash. It is a comprehensive pre- and post-processing environment for finite element analysis, helping engineers to conceptualize, develop and test product designs. Used by the world's leading manufacturing companies as their standard tool for the creation and analysis of simulation models, Patran links design, analysis, and results evaluation.

Patran provides a rich set of tools that streamline the creation of analysis ready models for linear, nonlinear, explicit dynamics, thermal, and other finite element solutions. From geometry clean up tools that make it easy for engineers to deal with gaps and slivers in CAD, to solid modeling tools that enable creation of models from scratch, Patran makes it easy to create FE models. Meshes are easily created on surfaces and solids alike using fully automated meshing routines, manual methods that provide more control, or combinations of both. Finally, loads, boundary conditions, and analysis setup for the most popular FEA solvers is built in, minimizing the need to edit input decks.

Patran's comprehensive and industry tested capabilities ensure that your virtual prototyping efforts provide results fast so that you can evaluate product performance against requirements and optimize your designs.

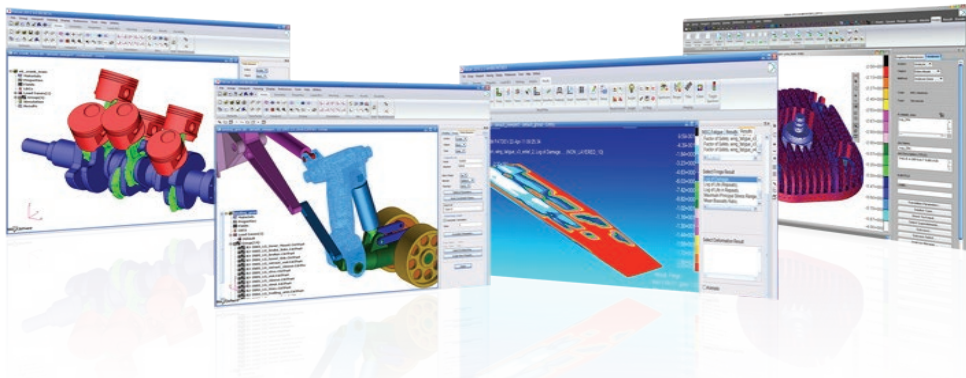

Capabilities

- Use an intuitive graphical interface with direct access of CAD geometry with automatic/interactive feature recognition
- Access multiple MSC Software and third-party solvers
- Utilize robust automatic surface and solid mesh generation with advanced surface mesh-on-mesh capability
- Model connectors and bolts with pre-loads
- Easily define full 3D general contact scenarios for nonlinear analyses
- Optimize your designs by setting up
- MSC Nastran optimization tasks
- Define supplements to analyse large FE models
- Create coupled analysis cases for Marc
- Use numerous post-processing tools to review your results
- Implement results standardization through results templates
- Customize your user interface through Patran Command Language (PCL)

Benefits

- Increase productivity of your design and development process
- Reduce development costs through increased use of simulation technologies
- Improve productivity and accuracy with multidiscipline analysis and optimization

MSC Fatigue

Patran works in conjunction with MSC Fatigue to provide comprehensive durability results for your assessment. MSC Fatigue is an FE-based durability and damage tolerance solver and can deal with the full range of fracture and fatigue life calculations for static and dynamic problems in both the time and frequency domain.

Testing against repeated loading cycles, sometimes millions of times over, is often too expensive and time-consuming to be practical. Finite element analysis programs can tell you where stress “hot spots” exist, but on their own can’t tell you whether those hot spots are critical areas for fatigue failure, or when fatigue might become a problem.

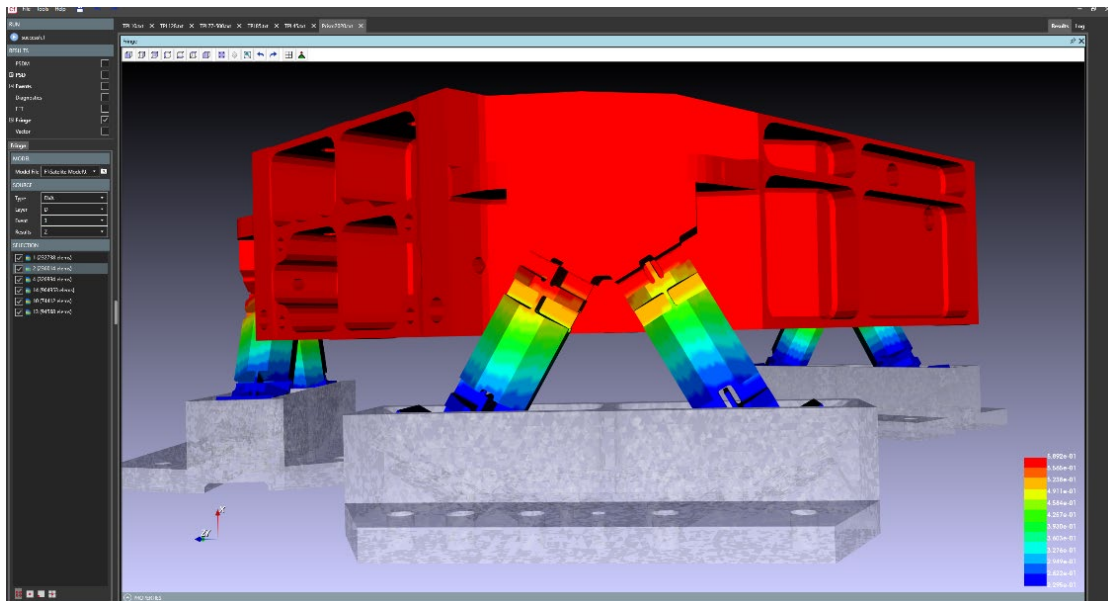

ODYSSEE – Optimal decision support system for engineering and expertise

Real-time solutions for engineering, manufacturing, and quality

ODYSSEE CAE - Solving your engineering problems in real-time

ODYSSEE CAE is a unique and powerful CAE-centric innovation platform that allows engineers to apply Machine Learning, Artificial Intelligence, Reduced Order Modelling (ROM), and Design Optimization to workflows. ODYSSEE CAE applies to all industrial design problems and is solver and physics independent, it works with Structural, Thermal, CFD, Acoustics (MSC Nastran, Marc, Adams, Cradle CFD, Actran, etc.). ODYSSEE CAE enhances your knowledge by answering complex engineering questions in real-time that would otherwise take hundreds of hours to simulate and analyse. With only a few previous CAE simulations or physical test data, ODYSSEE CAE predicts, optimizes, and robustly generates accurate results in real-time. ODYSSEE CAE produces full-time history outputs, including complete CAE analysis with detailed post-processing of results.

ODYSSEE A-Eye - Enabling real-time prediction and optimization using image-based machine learning for any industry

ODYSSEE A-Eye is an image-based machine learning solution that accelerates product design and development via real-time parametric simulation and optimization using machine learning and artificial intelligence (AI) solutions. ODYSSEE-A-Eye enables the creation of dedicated customizations for production/non-engineers using image data, sensor data, scalars, labels, curves, and CAD data as inputs and then predicts responses using the known data of your system. This insight enables designers and production technicians to explore the design space more extensively and interactively and improve next-generation products without prohibitive computing costs or time.



ODYSSEE includes:

- Machine learning & AI
- Statistics, data mining, data fusion
- Optimization and robustness
- Process discovery
- Image recognition and compression

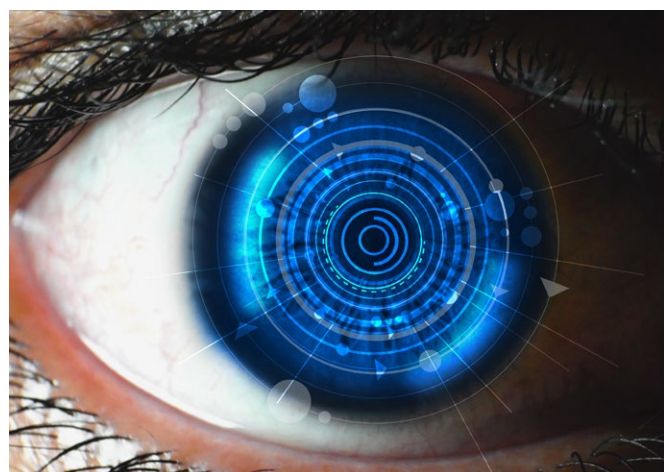

Predictive analytics software for working in the uncertain world

SmartUQ is a powerful predictive analytics and uncertainty quantification (UQ) software tool that incorporates real world variability and probabilistic behaviour into engineering and systems analyses. It was built from the ground up to solve some of the most challenging analytics problems faced by manufacturing companies. In industries like Automotive, Aerospace & Defense, Turbomachinery, Heavy Equipment, Medical Device, Semiconductors, Energy, Oil & Gas, Heating, Ventilation, and Air Conditioning and Consumer Products, SmartUQ software has saved our customers millions of dollars and thousands of hours of work.

Benefits

- Reduce duration of simulation and testing
- Catch problems early, reducing development time
- Prevent unnecessary design iterations
- Decrease costs
- Increased utility of simulations
- Fewer tests & prototypes
- Reduce cost associated with unexpected failures
- Improve quality and reduce risk
- Validate that the simulation agrees with reality
- Maximize product reliability and durability
- Meet oversight requirements (FAA, FDA, DoD)

Capabilities:

- **Modern design of experiment** tools designed to efficiently collect data from simulation, physical testing, or digital twins.
- **Unique data sampling** tools for subsampling or dividing large data sets into evenly distributed batches for building large-scale machine learning models.
- **Flexible predictive modeling and machine learning** tools to cover a wide range of scenarios including high dimensional problems, large sample sizes, spatial data, and functional/transient responses.
- **Statistical calibration** tools to determine model calibration parameters even with limited simulation and test data and provide model discrepancy to improve simulation and perform model validation.
- **Inverse analysis** tool to calculate the probability distribution of inputs based on a set of outputs from a system, helping verify hard-to-measure system properties.
- **Optimization library** handles multiple objectives and accommodates very large numbers of inputs.

- **Sensitivity analysis** library to rapidly determine which factors have a relatively low or high impact on the outputs, allowing engineers to focus efforts appropriately.

Easy-to-use software

- **User-friendly GUI** powerful, yet intuitive, SmartUQ is designed for Engineers and Data Scientists alike. SmartUQ's clean, straightforward user interface, including software wizards, makes performing complex analyses easier than ever before.
- **Integration** analytics software is only as powerful as it is compatible with other systems. SmartUQ has built-in integrations with MSC Software products like Adams, Digimat and NASTRAN. Additionally, with SmartUQ's application programming interface (API), you can seamlessly integrate SmartUQ tools into your workflow. SmartUQ's API significantly reduces time spent on performing analyses while still providing the full benefits of its GUI.
- **Automated predictive modeling** with an existing data set or a connected simulation model, SmartUQ runs, builds, and compares predictive models until it meets your accuracy requirements.

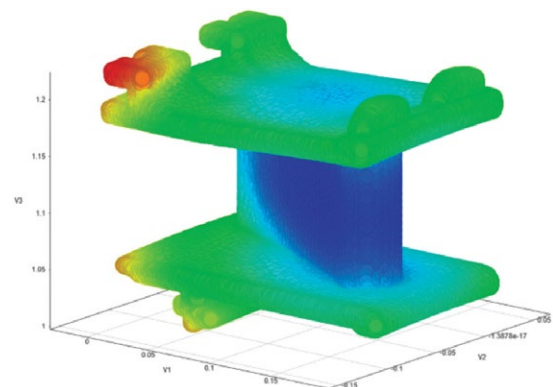

SimManager

Simulation process and data management

SimManager is a unique Simulation Process and Data Management (SPDM) system that manages all aspects of CAE simulation. It is focused on meeting the sophisticated data management and processing needs specific to the simulation community. Our customers appreciate our deep understanding of CAE issues and how insights gained from experiences can be captured using SimManager to help them achieve higher efficiency. MSC Software provides a complete solution that brings together people, process, and technology to streamline simulation operations.

SimManager is a web-based simulation data and process management system that manages all simulation data and processes from project initiation through final report generation. Using SimManager, simulation operations become more productive and effective, reducing the cost and time it takes to bring better products to market. Effective implementation also helps meet the required certification requirements where needed, and storage and recovery of data when needed in a secure manner.

Competitive advantages that scale from a small workgroup to company-wide use include:

- Increased productivity
- Improved quality
- Standardization and establishment of best practices
- Effective collaboration
- Integrated teamwork
- Shorter product development times
- Accelerated process and product innovation
- Data traceability



Process management and automation

- Automation reduces manual execution of intensive, repetitive simulation tasks and processes
- Work request and workflow notification keep projects on track and enable management oversight
- Dashboards enable quick evaluation of studies and scenarios relative to design targets
- Built-in job queue interface optimizes execution of simulation processes and solver runs
- Simulation processes, input and output are documented via Audit Trail
- Open support of tools and applications, including MSC, 3rd party, and in-house applications
- Leverages existing hardware and software infrastructure
- Web-based configuration enables fast deployment

Enterprise integration

- Integrated access to SimManager from MSC applications
- Web-browser access to 3rd party simulation applications and other popular engineering tools
- PDM integration using PROSTEP OpenPDM technology
- Integration with Requirements Management systems
- Fully compatible with job queuing and submission systems including MSC Analysis Manager, LSF, Sun Grid Engine, and PBS Pro
- Test Data integration and comparison

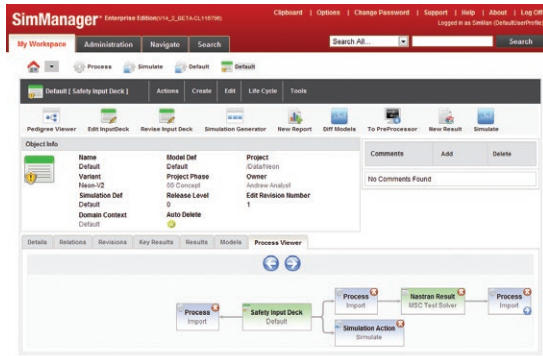

MaterialCenter

Materials lifecycle management

MaterialCenter is a Materials Lifecycle Management System designed to link material specialists to mechanical simulation. MaterialCenter captures data from integrated processes to ensure full traceability across the enterprise and throughout the product lifecycle. It addresses unique process and data requirements and drives product innovation in complex materials such as alloys, elastomers, plastics, composites, and many more. MaterialCenter works directly with many commercial CAE products and delivers on-demand commercial databanks to engineers across the industry.

Drawn from the collective experience of the world's largest OEMs, MaterialCenter is the single point of entry for all materials related activities including physical test data entry and reduction, multi-scale materials modelling, approval workflow and the export of simulation ready data to analysis. This guarantees that engineers are using a consistent source of approved materials derived from traceable integrated processes, resulting in improved simulation fidelity, reduced data loss and elimination of tedious manual data management activities.

Reducing development time and cost of composites materials is on the main agenda for all organisations to remain competitive and to penetrate markets. A powerful tool to achieve that is Integrated Computational Materials Engineering – or in simpler words – simulation to predict and virtually test composite materials. Furthermore, when organisations apply this method, they quickly realise the amount of data that needs to be captured and validated, both virtual (ICME) and physical data for validation. An innovative product integration between MaterialCenter and Digimat can enable this methodology and solve key challenges in this area.

Using MaterialCenter – a powerful data management solution, and Digimat-VA – Virtual materials simulation and prediction solution – together, creates a powerful combination to not only apply ICME to reduce costs and development time by reducing number of physical tests, but also solving a key challenge in the industry to manage the vast amount of data generated and enable comparison, analysis, and validation. For example, qualification of materials will always require physical testing to be conducted, along with simulations. With this powerful integration of two products, comparing both sets of data, keeping traceability and connection, and enabling comparison of properties of both physical and simulation is made effortless.

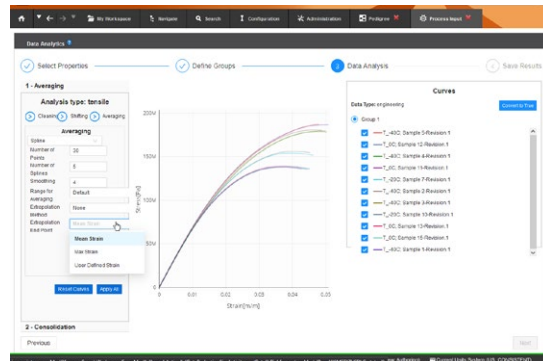
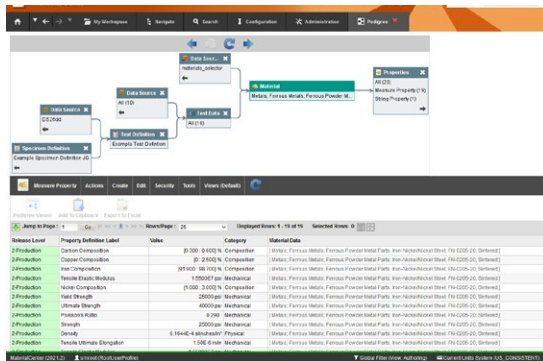

Capabilities

- Dashboards for quick evaluation of materials data management projects and management oversight
- Work request and approval workflow to keep projects on track
- All materials-related processes, input and output are documented via Audit Trail
- Process-oriented, automation approach to data management implemented to minimize manual data entry activities
- Robust and intuitive interface for data search, retrieval, and comparison for all data types – tabular, curves, images, etc.
- Web-based interface to data management processes enables distributed data authoring and maintenance
- Built-in job queue interface optimizes execution of materials simulation processes
- Integration with Excel, Digimat, and 3rd party applications that support materials data

10xICME solution

The 10xICME (Integrated Computational Materials Engineering) solution will help you save millions of dollars in the material development process. It has been devised to address both business and engineering challenges in the materials development and utilisation process. Developed in collaboration with global OEMs and material suppliers, 10xICME is applicable to a wide range of materials, including plastics, composites, ceramics and manufacturing processes, such as injection moulding, automatic fiber placement and additive manufacturing. We shoot to deliver ROIs of 10x productivity, 10x quality, 10x cost savings and 10x time-to-market.

processing PDM integration using PROSTEP OpenPDM technology

- Auto-capture of all data transactions
- Web-based configuration that enables fast deployment
- Configurable to support multiple global locations

Benefits

- Fast deployment and lower IT support costs
- Reduced data related inefficiencies through use of consistent source of approved materials derived from traceable integrated processes
- Rapid deployment methodology to ensure immediate productivity gains
- Scalable solution that adapts to changing organisational needs and results in lower maintenance and IT costs

Virtual Test Drive (VTD)

Accelerating autonomous driving

VTD is the world's most widely used open platform for the creation, configuration, and animation of virtual environments and scenarios for training, testing, and validation of ADAS and Autonomous Vehicle systems. It provides a modular toolset for road network creation, scenario definition, vehicle dynamics, traffic and sound simulation, simulation control, image generation, sensor perception, etc. to create a digital reality for complex driving scenarios. It can be widely used in MiL, SiL, HiL, DiL, and ViL applications to accelerate the development of ADAS and AD systems. Recent advances in VTD have allowed it to do massive scaling of scenarios on the Cloud thus helping in 'edge case' detection. This is done by analysing millions of scenarios with thousands of parallel processes allowing for billions of virtual test miles to be done faster than real-time simulation, enabling an increased speed of deployable for ADAS and AD systems.

Hexagon helps define open standards such as from OpenDRIVE, OpenCRG, and OpenSCENARIO:

- OpenDRIVE is the leading global open format and the de-facto standard for the description of road networks in driving simulation applications.
- OpenCRG is the leading open-source data format and tool-suite for the creation, management, and evaluation of detailed road surfaces.
- OpenSCENARIO is the state-of-the-art open format for the definition of dynamic behaviour in simulated road networks.

VTD's Road Designer (ROD) is an interactive road network editor, which is used as the basis for 3D world creation. It consists of extensive libraries of 3D objects and textures representing different countries, and it provides for the creation of either complete databases or elemental building blocks (so-call 'tiles').

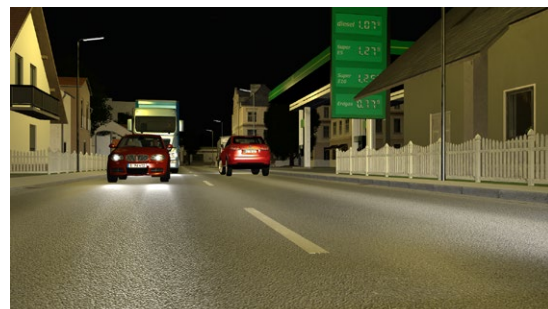
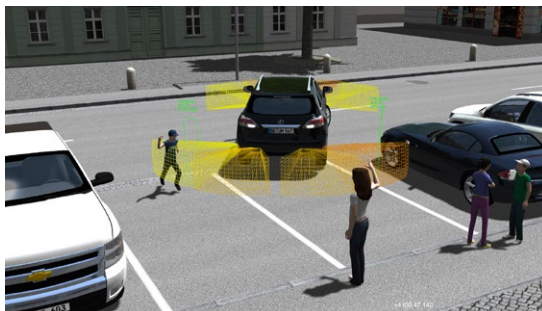

Capabilities

Sensors

- Physics-based configurable sensor models and ground truth data raw data like images and point clouds
- Sensors are used for road mark detection
- SDK for customization of sensor models

Pedestrian

- The capability of deterministic behaviour of pedestrians on a defined path
- Pedestrians moving in significant numbers autonomously in the road network while interacting with the system in the test (e.g., pedestrian looking at the vehicle, coming towards the vehicle)

Scenarios

- Simulations from simple maneuvers to complex urban situations with 200+ participants
- Scenarios may be retrieved from real world measurements or are completely artificial

Vehicle Model

- Model development with “to the scale” with a precision of millimetres deflections for all modes of transport ranging from Scooters to trains and helicopters
- Capabilities to build the models from a photograph with a minor offset

Weather

- Variations of time-of-day, clouds, visibility, precipitation

Traffic Model

- Simulation of independent, intelligent agents that each can act either autonomously or in deterministic mode

Massive parallel testing

- Analysis of thousands of scenarios in parallel to detect edge cases
- PDM integration using PROSTEP OpenPDM technology
- Auto-capture of all data transactions
- Web-based configuration that enables fast deployment
- Configurable to support multiple global locations

Benefits

- Native support for OpenDRIVE®, OpenCRG®, and OpenSCENARIO®
- Extremely modular and scalable via its network interfaces
- Can be integrated on any platforms (MiL, SiL, DiL, ViL, HiL)
- Contains accurate sensor models (object-list based and physics-based), customizable via SDK
- Generates high-quality images (PBR technology), customizable via SDK
- Contains various libraries of 3D models and country-specific signs/signals databases
- Enables the simulation of complex traffic situations
- Easy data monitoring and injection in real-time through GUI or command lines
- Operable from a single computer up to a full scale HPC environment
- Couple to other Hexagon solutions like Adams Real Time for physics-based vehicle dynamic models• Takes data from Hexagon’s Leica Geosystems cameras
- Takes data from Hexagon’s Leica Geosystems cameras
- Edge case detection among a thousand scenarios and cloud base support

FORMINGSUITE®

Smart process planning, cost engineering, and early feasibility solutions for the sheet metal industry

FORMINGSUITE® is the industry standard technology for Cost Engineering, Material Utilisation, Process Planning, Design for Manufacturability (Evaluate BIW and Class A Panels Formability and Quality), and Stamping Simulation for Sheet Metal Components. Within the powerful FormingSuite environment FTI provides the following software solutions:

- COSTOPTIMIZER® Professional for cost engineering.
- COSTOPTIMIZER® Advanced for early feasibility.
- FASTIncremental for robust stamping simulation for sheet metal components (Virtual Manufacturing).

CAD integrated solutions for cost engineering and early feasibility are also available.

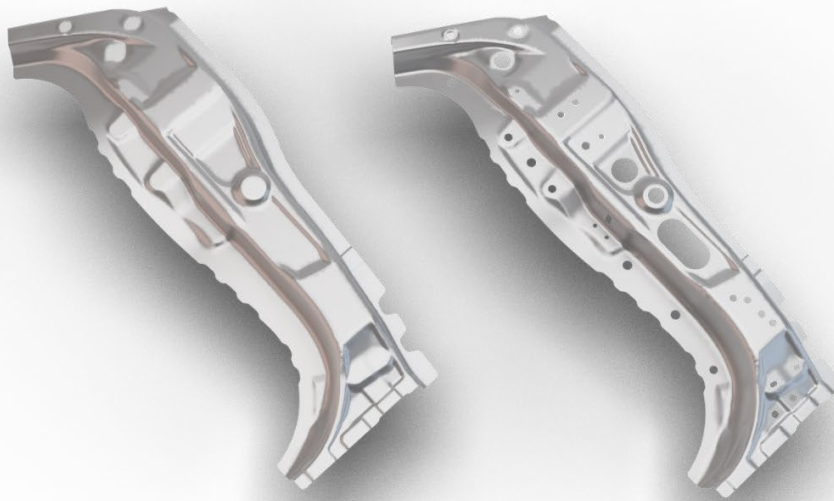

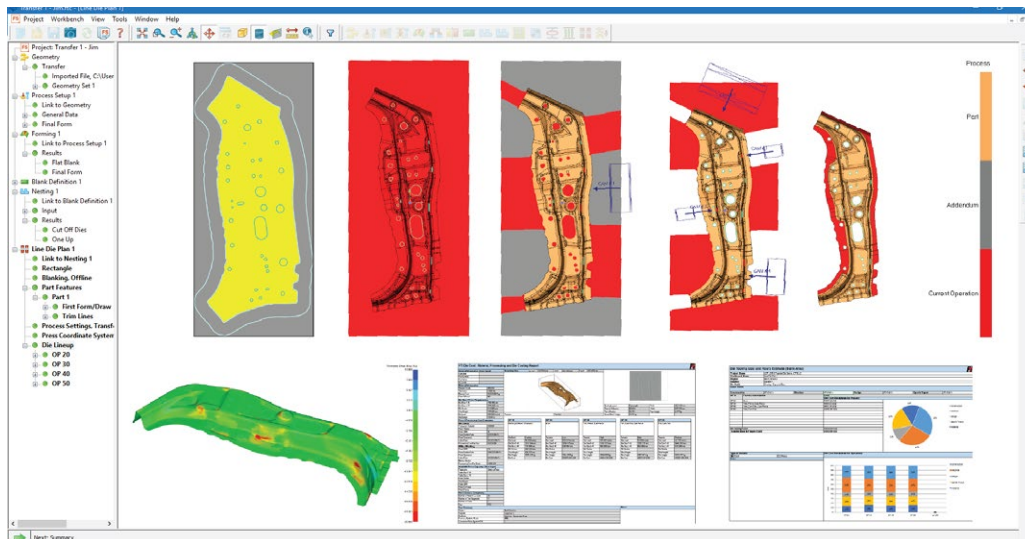

Capabilities

- Intelligently and automatically address the material cost improvement areas for management and engineers to work as a team, to improve material utilisation and reduce material spend.
- Identifies product design changes that improve quality, material utilisation, and reduce weight and costs for optimal material usage.
- Scientific physics-based approach identifies formability issues at product design stage reducing ECOs.
- Accurately identifies splits and wrinkles using Forming Limit Diagram (FLD) & safety zones in addition to thickness strain, major/minor strain, etc.
- Calculates springback to predict issues for tooling and provide information for tolerance negotiation and provides compensation data.
- Establishes target cost for piece price and tooling with a detailed process plan for quoting.
- Calculates press requirements such as tonnage, bed size, shut height, energy, and selects appropriate press.
- Powerful stamping analysis package for blank development, process design validation, and virtual prove-out using both incremental and coupled hybrid inverse stamping simulation.

Benefits

- Provide a holistic enterprise solution automatically to intelligently identify areas for improvement and optimisation strategies for sheet metal costing at the whole vehicle level.
- Addressing Design for Manufacturing issues early in the design phase to reduce engineering changes resulted from formability issues downstream and reduce the overall time to market.
- Perform accurate quotations in less than half the time using “FTI Technologies” enabling a cost engineer to perform over 2000 quotes per year.
- Reports for customer technical review can be produced simultaneously with the quote to include blank layouts, feasibility simulations, and tool process description with pictorial layouts and cost breakdowns for tool value analysis.
- Instantaneous feedback for equipment requirements including press tonnage and bed sizes so early capacity planning can be carried out to establish maximised equipment utilisation of current and new requirements well ahead of time.
- Consistent and repeatable method for estimating tooling costs with detailed reports that connect to any system.
- Seamlessly integrated tools provide simulation and validation of the entire process from quoting to tooling design to virtual prove-out with speed and efficiency in a simple and intuitive user interface.



Global engineering services

Working with you where you are to accelerate the benefits of CAE simulation

Industry experience

Our Engineering Services organization is a team of local engineers and scientists with expertise across a wide range of engineering disciplines and industries. We have a 50-year history of real world hands-on practical experience with thousands of years of support know-how to help you be successful with CAE.

CAE expertise you can trust

If you want simulation results you can trust and the flexibility of working with extremely skilled engineers who know Computer Aided Engineering (CAE) and how it's applied to engineering problems like yours, we have a team you can rely on to improve your product development process. Our Engineering Services team near you can help in a variety of ways:

- Quick start projects
- Simulation projects
- Customisation and process automation
- Methods development and toolkits
- Simulation process and data management
- Know-how transfer
- Mentoring; on-site or virtually
- Expertise training
- Staff augmentation
- On-site support

For more information contact: info@mscsoftware.com

Flexible services offerings

We provide consulting support based on your specific needs and requirements.

This could range from performing analysis for you on a project basis; multiple times a year or providing full time staff members to help you create repeatable processes in-house.

You can depend on our engineering services staff to:

- Save you time
- Automate your CAE processes
- Perform project-based simulations
- Get your team up to speed with CAE
- Mentor and support your staff
- Correlate and validate CAE results with test data

Applied solutions group

Comprehensive end-to-end design expertise delivering turnkey engineering projects

Partnering with you for success

A dedicated global engineering services team comprised of experienced mechanical, electrical and electronic engineers addressing the biggest industrial pain points. Through projects ranging from rapid turnkey design and development to process enhancements, we partner to meet your goals.

From our first engagement with you, we look holistically at your requirements and processes to determine the optimum solution tailored to your needs. We have 30+ year track record of delivering thousands of outsourced projects with hundreds of repeat customers across multiple industries globally, who have developed project design IP together with us.

Applied Solutions Group (ASG) delivers innovative, robust and functional designs, knowledge transfer to develop your own capability for future projects. We help you enter new markets and develop new business models by accelerating your development cycle utilizing the breadth of our Hexagon and partner technologies.

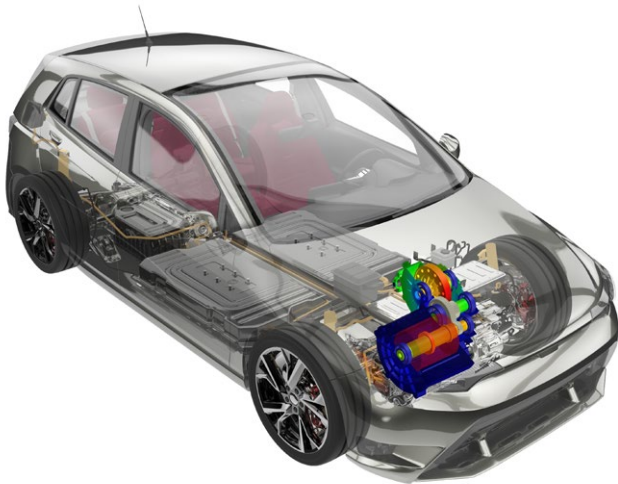

Challenge

Customer wanted to develop a 3-in-1 Electric Drive Unit (EDU) to move up the value chain but lacked internal capability and resource to deliver.

Solution

ASG developed an integrated EDU with multispeed transmission, high speed motor, integrated park lock for customer.

Benefit

Went from blank sheet of paper to delivered design in 12 months with delivery of Design IP and comprehensive Knowledge transfer to allow customer to build capability for future projects.

Challenge

Customer needed to develop next generation wind turbine drivetrains in aggressive timeline to meet.

Solution

Outsourced design and development of 5, 8 & 10MW wind turbine drivetrains to ASG.

Benefit

Received all complete set of CAD, manufacturing drawings and Design IP. Supported through manufacture and certification.

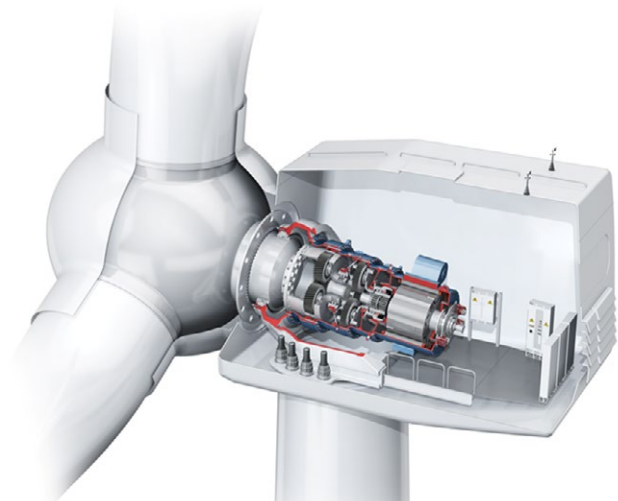

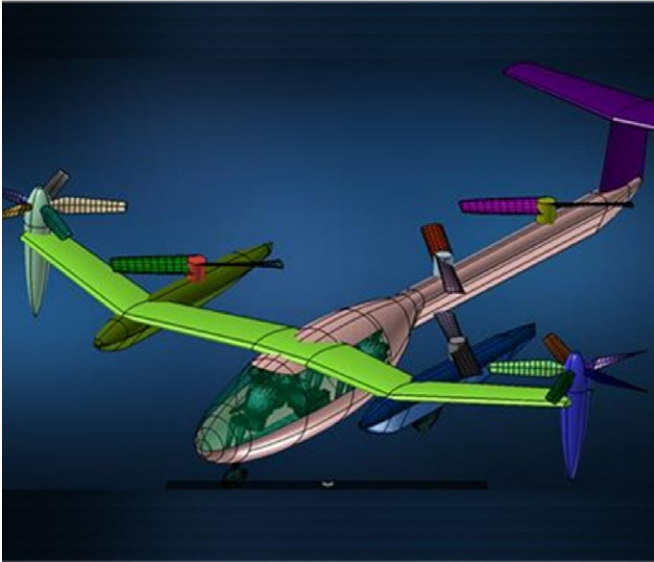

Challenge

Customer wanted to bring drivetrain design capability in-house for next generation Vertical Take-off Aircraft

Solution

ASG provided a comprehensive technology enhancement program providing training in fundamental theory, design approach and aerospace industry requirements

Benefit

Customer was able to establish a team to bring drivetrain design capability in-house

Benefits

- Accelerate your innovation to bring products to market faster and at lower cost
- Receive all the design IP
- Gain in-house capability through Engineering Knowledge Transfer
- Trusted, accredited, and experienced long-term partner
- Industry Leading solutions for geared and electro-mechanical systems development

Approach

- Multi-disciplinary integrated engineering project team that operates globally
- System engineering aligned to the robust V-lifecycle model and development stages
- MBSE workflows leveraging rapid analysis and CAE tools
- Utilise cross-sector engineering experience covering automotive, aerospace, rail, marine, defense, wind, nuclear, & more



Combining proven software and engineering expertise from Hexagon gave us the confidence to take the risk of eliminating a full prototype iteration, relying heavily on virtual simulation. With this new approach, we have achieved a 7-to-9-month reduction in development time.”

Jérôme Mortal

Transmission Systems Product Group R&D and Electrification
Director at Valeo



For more information contact: info@mscsoftware.com

Training

Our engineering simulation software courses are designed to provide you with exclusive product knowledge. Our course developers and instructors work with product developers to gain exposure to new product capabilities. This unique insight is shared with you through official courseware that incorporates the most useful tips and techniques. When it comes to quality instruction in a classroom setting, you can trust Hexagon's design & engineering software. Whether you're a student looking to advance your career or start a new one, or a team leader looking to make sense out of new technology, you're virtually guaranteed to find a course that will best suit your training requirements. We offer a variety of Standard Courses as well as Custom Courses, held at our training facility or at the customer's site.

Flexible training offerings

To further meet your specific requirements, we offer the following options for live instruction.

- Public classroom training – Choose from our wide selection of courses conveniently offered at sites throughout the world.
- Public online training - The convenience of on-line learning with the interactivity and depth of a traditional classroom setting – no travel required. The entire instructor-led course is live and online on your own computer. Live Online Training is an efficient, cost effective and convenient way to gain skills in the use of our MSC simulation software.
- Training at your facility – If you have several employees who need training, we offer the cost-effective option of bringing our class to your facility. This eliminates employee travel costs, minimizes time away from work, and can be arranged at your convenience.
- Custom courses – If our standard seminar offerings do not meet your training requirements, MSC can develop a course or set of courses tailored to your specific needs. A custom course might include a combination of topics from several standard courses or specialized material not found in any of our standard seminars.

We can deliver custom and private courses live or via the web. We can also help ensure that you have the adequate hardware and software licenses available for private courses. Please refer to our engineering software training website for detailed course descriptions and dates offered at sites throughout the world.

Visit mscsoftware.com/msc-training to access our Global training schedule.

MSC Learning Center

eLearning – we offer several training courses in an interactive format with audio from subject matter experts. With the complete training content that includes lectures, workshops, demos, and workshop review questions in a format that you can complete in a self-paced and self-directed manner, you can keep up and improve the simulation skills helpful to your work.

Visit mscsoftware.com/msc-training to access our training courses.







Hexagon is a global leader in digital reality solutions, combining sensor, software and autonomous technologies. We are putting data to work to boost efficiency, productivity, quality and safety across industrial, manufacturing, infrastructure, public sector, and mobility applications.

Our technologies are shaping production and people-related ecosystems to become increasingly connected and autonomous – ensuring a scalable, sustainable future.

Hexagon's Manufacturing Intelligence division provides solutions that use data from design and engineering, production and metrology to make manufacturing smarter. For more information, visit hexagonmi.com.

Learn more about Hexagon (Nasdaq Stockholm: HEXA B) at hexagon.com and follow us [@HexagonAB](https://twitter.com/HexagonAB).